

TT
185
R-7

AGRICULTURAL
WOODWORKING

LOUIS M. ROEHL



Class TT 185

Book 187

Copyright N^o _____

COPYRIGHT DEPOSIT.

Agricultural Woodworking

A GROUP OF PROBLEMS FOR

Rural and Graded Schools, Agricultural High Schools
and the Farm Workshop

By

Louis M. Roehl

Director of Farm Mechanics,
Milwaukee County School of Agriculture
and Domestic Economy,
Wauwatosa, Wisconsin

The Bruce Publishing Company

MILWAUKEE, WIS.

TT185
R7

Copyright 1916
The Bruce Publishing Company

#150

AUG 31 1916

17-18631

© Cl A 438332

2001

PREFACE

THE manual training which is offered in the rural schools, graded schools and agricultural high schools should be principally of an agricultural nature. Work of this kind has a tendency to keep the boys in school for a longer period of time. It creates a desire to use tools in making farm necessities and improving farm buildings and equipment. It develops a closer relationship between the school and the home. It trains the eye and hand and develops patience, perseverance, judgment and accuracy. It creates a desire to equip and use a shop at home. It has a bearing on making the boys want to stay on the farm.

It is with these thoughts in mind that this book on agricultural woodworking has been prepared. It is intended that it be used by the boys both at school and at home in the farm workshop as an aid to efficient farming.

CONTENTS

Page	Page
Preface.....	3
Woodworking Equipment for Country Schools.....	5
Directions for Reducing Stock to Dimensions.....	6-7
Bread Board.....	8-9
Bench Hook.....	10-11
Feeding Trough for Chicks.....	12-13
Fly Trap.....	14-15
Folding Bench.....	16-17
Nail and Staple Box.....	18-19
Bird House.....	20-21
Window Screen.....	22-23
Tool Sharpening.....	24
Saw Filing.....	25
Milking Stool.....	26-27
Ironing Board.....	28-29
Wagon Jack.....	30-31
Community Bird House.....	32-33
Chicken Feed Hopper.....	34-35
Chicken Brooder Coop and Run.....	36-37
Eveners and Singletree.....	38-39
Fence and Gate.....	40-41
Bench.....	42-43
Rabbit Trap.....	44-45
Seed Corn Curing Frame.....	46-47
Seed Corn Tree.....	46-48
Chicken Brooder Coop and Run.....	49-50-51
Clothes Line Reel and Kitchen Stool.....	52-53
Step Ladder.....	54-55
Swinging Farm Gate.....	56-57
Trap Nest.....	58-59
Hive Seat and Tool Box.....	60-61
Ladders.....	62-63
Carpenter's Tool Box.....	64-65
Two-Man Weight Carrier.....	66-67
Saw Horse.....	68-69
Lawn or Porch Seat.....	70-71
Daily Milk Record Sheet Case.....	72-73-74
Oats Sprouter.....	75-76-77
Fruit Ladder.....	78-79
Wagon Box.....	80-81
Flat Hay Rack.....	82-83
Carpenter's Work Bench.....	84-85-86
A Farm Work Shop.....	87-91
Ensilage Rack.....	92-93
Roughage Feed Rack for Swine.....	94-95
Roughage Feed Rack for Cattle.....	96-97
Hay Rack.....	98-99
King Road Drag.....	100-101
Grain Bed.....	102-103
Garden Wheelbarrow.....	104
Land Leveler.....	105
Planker.....	106
Wagon Bed.....	107
Wagon Box.....	108
Top Wagon Box.....	109
Stock Rack.....	110
Silo Form.....	111-112
Farm Buildings.....	113
Portable Hog House.....	114
Colony Poultry House.....	115-116
Poultry House.....	117
Pigeon House.....	118
Hog House.....	119
Implement Shed.....	120
Corn Crib.....	121
Combination Dairy and Horse Barn.....	122-125
Combination Horse and Cow Barn.....	126
Plan for a Farmstead.....	127
Knots and Splices.....	128-133
Lacing a Belt with a Rawhide Thong.....	134
Lacing a Belt with Metallic Wire Belt Lacing.....	135
Tools.....	136-137

WOODWORKING EQUIPMENT FOR COUNTRY SCHOOLS

1—22-inch Hand Rip Saw 8 Point.....	\$1.50
1—22-inch Hand Cross Cut Saw 8 Point.....	1.50
1—Claw Hammer, 12 oz. Straight Claw, Plain Face .	.55
1—Jack Plane, 14-inch with 2-inch Cutter.....	2.15
1—Try Square, 8 inch.....	.35
1—T bevel, 8 inch.....	.30
1—Marking Gauge No. 0.....	.10
1—Divider, 8 inch.....	.35
1—Carpenter's Mallet, 2 $\frac{3}{4}$ x3 $\frac{3}{4}$ inches.....	.25
1—2-foot Four Fold Rule, Brass Bound.....	.35
1— $\frac{1}{4}$ -inch Socket Firmer Chisel.....	.35
1— $\frac{1}{2}$ -inch Socket Firmer Chisel.....	.35
1— $\frac{3}{4}$ -inch Socket Firmer Chisel.....	.40
2—Bench Stops.....	.10
1—8-inch Bench Brush.....	.35
1—12-inch Handy Saw.....	1.25
1—Steel Rafter Framing Square.....	1.75
1—Bench Hook.....	.35
1—6-inch Screw Driver.....	.30
1—10-inch Screw Driver.....	.50
1—Ratchet Brace, 8-inch Sweep.....	1.10
1—10-inch Flat Bastard Mill File, with Handle.....	.25
1—6-inch Slim Taper Triangular File, with Handle...	.10
1—8-inch Drawing Knife.....	.70
1—Nail Set, 3-32 inch.....	.10
1—Rose Countersink.....	.15
1—Set Twist Drill Bits.....	1.25
1—2x8-inch Combination Carborundum Stone.....	1.00
1—Special Saw Set.....	.40
1—6-inch Combination Plier.....	.30
1—Putty Knife.....	.15
1—Set of Six Auger Bits, $\frac{1}{4}$, $\frac{3}{8}$, $\frac{1}{2}$, $\frac{5}{8}$, $\frac{3}{4}$, 1 inch.....	1.50
1—Coping Saw, Nickel Plated, Wire Frame.....	.25

\$20.35

For illustrations of tools see pages 136-137.

DIRECTIONS FOR REDUCING STOCK TO DIMENSIONS

- 1—Plane one side smooth and mark "I." Call this side the working face. Fig. 1.

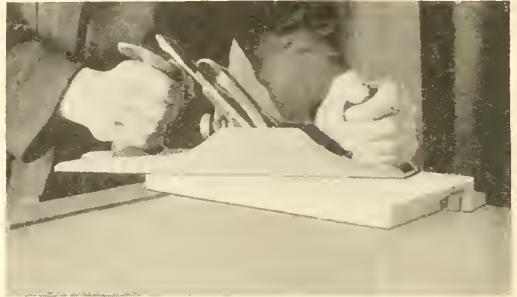


Fig. 1. Holding Wood Between Bench Pegs and Planing Surface.



Fig. 2. Edge Planing.

- 2—Plane one adjoining edge at right angles to surface "I," and mark "II." Call this edge the working edge. Fig. 2.

- 3—Draw a line across surface "I" near one end at right angles to surface "II," and remove the end stock to line with saw or plane. Mark end surface "III." Call this end the working end. Fig. 3, Fig. 4.



Fig. 3. Squaring the End with Try Square and Pencil.

4—Measure off the length of the required piece on surface "I" from the end surface "III," and reduce stock to length with saw or plane. Fig. 4.



Fig. 4. Sawing Cross Grain on Bench Hook with Back or Handy Saw.

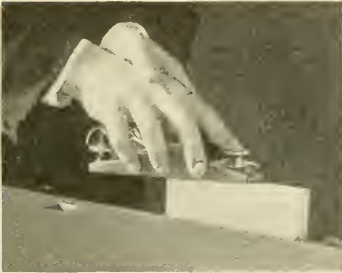


Fig. 4a. End Planing with a Block Plane.

4a—The end may be trimmed with a block plane as shown. Fig. 4a.

5—Measure off the width of the required piece on surface "I" from edge "II" and remove stock to line with plane.
6—With marking gauge set at the thickness of the required piece, measure off the thickness of the required stock from surface "I" and remove stock to line with plane. Fig. 5.



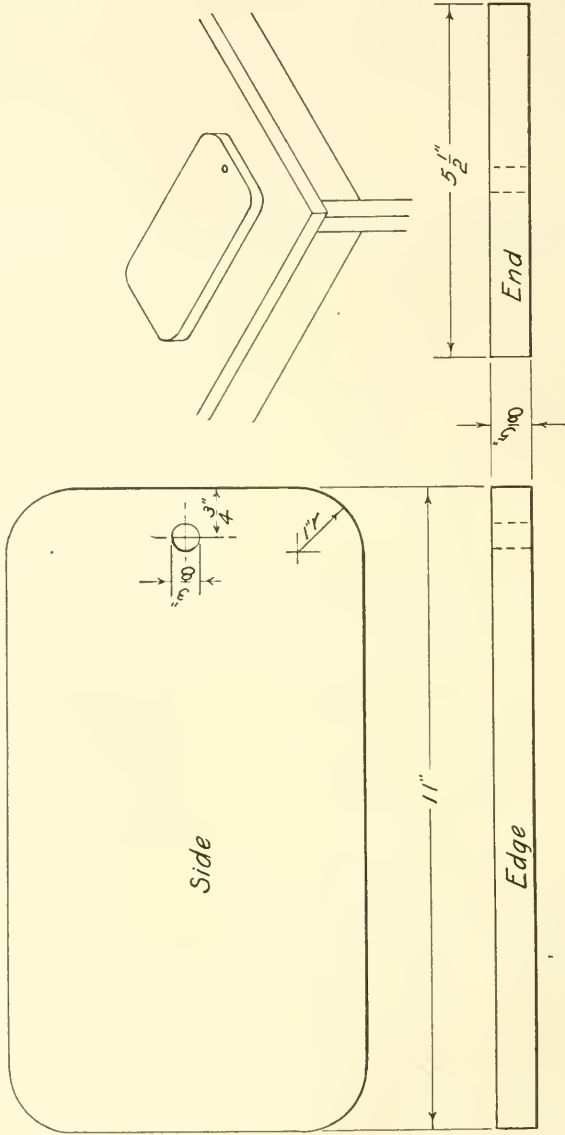
Fig. 5. The Marking Gauge in Use.



Fig. 6. Testing to See if End is Square with the Edge.

6—In reducing a piece of wood to dimensions the try square should be used constantly, to obtain right angles with the adjoining surfaces. The stock should be removed to the line but the line should never be cut away. Fig. 6.

Bread Board



BREAD BOARD

Material Required

Lumber: 1 piece basswood, poplar or white pine $\frac{1}{8} \times 5 \frac{5}{8} \times 11 \frac{1}{2}$ inches.

Tools

Sharp lead pencil, rule, try square, jack plane, handy saw, brace, $\frac{3}{8}$ inch bit, $\frac{3}{4}$ inch chisel, marking gauge, dividers.

Stock Bill

Pieces. Finished Dimensions.
1. $\frac{3}{8} \times 5 \frac{1}{2} \times 11$ inches.



Fig. 7. Swinging an Arc with a Compass.

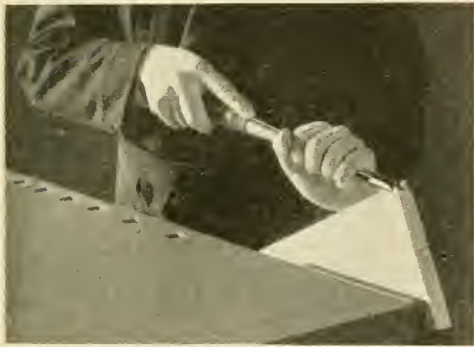


Fig. 8. Chiseling with the Grain.

Directions

- 1—Reduce stock to finished dimensions following the above directions.
- 2—To lay out round corners locate points at each corner on both sides 1 inch from end and 1 inch from edge, and with dividers set at a 1-inch radius swing an arc across the corner to edge and end. Fig. 7.

- 3—Draw a line across edge and end at each corner 1 inch from the corner so that the proper amount of stock may be removed.
- 4—Remove stock at corner with $\frac{3}{4}$ inch chisel, cutting with the grain. Fig. 8.



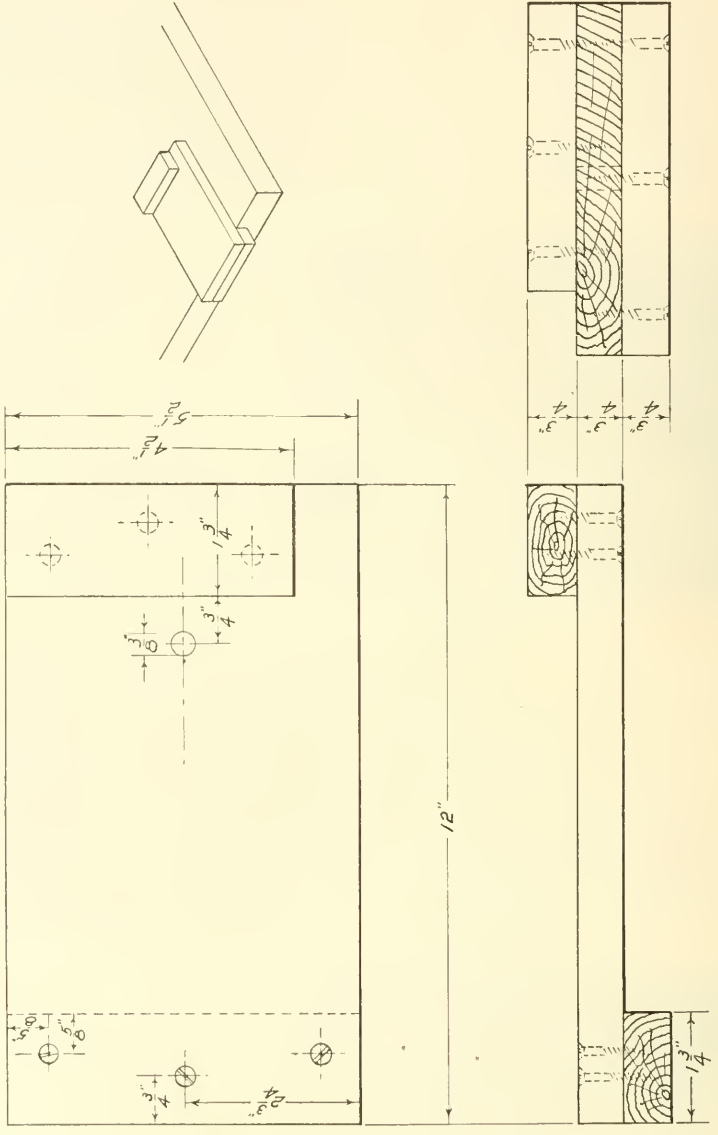
Fig. 9. Boring a Hole.



Fig. 10. Feeling for the Point of the Bit.

- 5—Locate a point $\frac{3}{4}$ inch from one end on a center line drawn lengthwise of the stock and bore hole with $\frac{3}{8}$ inch bit. Bore from one side until the point of the bit comes through, then turn the board and finish from the other side. This prevents splitting of the wood around the hole. Fig. 9, Fig. 10.

Bench Hook



BENCH HOOK

Material Required

Lumber: 1 piece white or yellow pine,
 $\frac{43}{16} \times 5\frac{5}{8} \times 10\frac{1}{2}$ inches.

1 piece white or yellow pine
 $\frac{43}{16} \times 1\frac{7}{8} \times 11$ inches.

(Cypress or Oregon pine may be substituted for white or yellow pine.)

Hardware: 6 flat head bright wood screws
 $1\frac{1}{4}$ inch, No. 8.



Fig. 11. Position to Hold Sand Paper and Sand Block.



Fig. 12. Setting a Plane.

Tools

Sharp lead pencil, rule, try square, jack plane, handy saw, brace, $\frac{3}{8}$ inch bit, No. $\frac{5}{16}$ inch twist drill, countersink, screw driver.

Stock Bill

Pieces.	Finished Dimensions.
1.	$\frac{3}{4} \times 5\frac{1}{2} \times 10$ in.
1.	$\frac{3}{4} \times 1\frac{3}{4} \times 5\frac{1}{2}$ in.
1.	$\frac{3}{4} \times 1\frac{3}{4} \times 4\frac{1}{2}$ in.

Directions

- 1—Reduce all pieces to finished dimensions.
- 2—Draw a center line lengthwise of big piece.
- 3—Locate a point on line just drawn $2\frac{1}{4}$ inches from one end and bore $\frac{3}{8}$ inch hole.
- 4—Locate points on each of the small pieces for screws.
- 5—Bore holes for screws with $\frac{5}{16}$ inch twist bit and countersink the holes.
- 6—Clamp all pieces accurately in position in vise and assemble with screws. If white pine or other soft wood is used the screws may be forced into the large piece without drilling a hole, but if yellow pine or other hardwood is used a hole should be made for starting the screw with a smaller bit than that used for the shank of the screw.

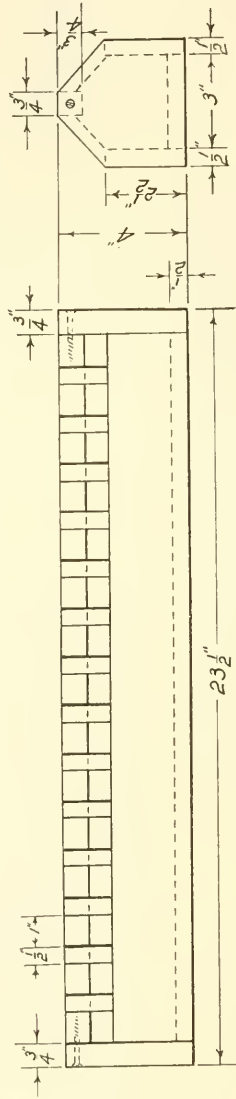
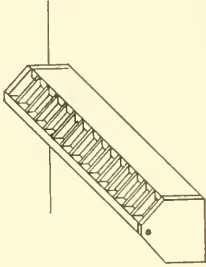
The screw driver should be held straight and pressed firmly so as not to mar the slot in the screw.

The hole for the head of the screw should be countersunk so that the head is slightly below the surface of the wood.



Fig. 13. Countersinking a Hole.

Feeding Trough for Chicks



FEEDING TROUGH FOR CHICKS

Material Required

Lumber: 1 piece cypress, white pine or basswood, $\frac{1}{8}$ "x $1\frac{1}{2}$ "x9 inches.
 1 piece cypress, white pine or basswood, $\frac{1}{8}$ "x $\frac{1}{8}$ "x22 $\frac{1}{2}$ inches.
 1 piece cypress, white pine or basswood, $\frac{1}{2}$ "x9x30 inches.
 (Poplar or redwood may be substituted for cypress, white pine or basswood.)

Hardware: 2 flat head bright wood screws, $1\frac{1}{2}$ inch No. 10.
 5 dozen $\frac{7}{8}$ inch brads.
 16 $1\frac{1}{4}$ inch brads.
 12 4d finishing nails.

Tools

Sharp lead pencil, rule, try square, T bevel, jack plane, hammer, brace, $\frac{3}{16}$ inch twist drill, countersink, nail set, screw driver.



Fig. 14. Proper Position to Hold Screw Driver

Stock Bill

Pieces.	Finished Dimensions.	Use.
2.	$\frac{3}{4}$ "x4 x4 inches.	Ends.
1.	$\frac{3}{4}$ "x $\frac{3}{4}$ "x22 inches.	Ridge.
1.	$\frac{1}{2}$ "x3 x22 inches.	Bottom.
2.	$\frac{1}{2}$ "x2 $\frac{1}{2}$ "x22 inches.	Sides.
28.	$\frac{1}{2}$ "x $\frac{1}{2}$ "x 2 $\frac{1}{4}$ inches.	Partitions.

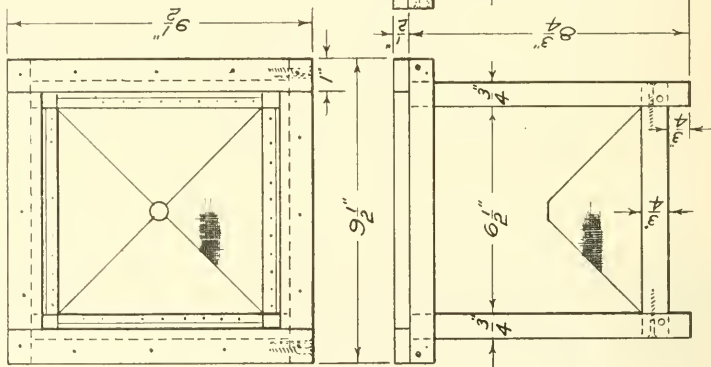
Directions

- 1—Reduce all pieces to finished dimensions.
- 2—To make the end cuts of the partitions hold the saw at 45° to a right angle.
- 3—Fasten ends to ridge with 1 $\frac{1}{2}$ inch No. 10 screw. Use $\frac{3}{16}$ inch twist drill for screw hole and countersink hole.
- 4—Fasten ends to sides and bottom with six 4d finishing nails at each end.
- 5—Nail sides to bottom with 1 $\frac{1}{4}$ inch brads. Use eight brads at each side spaced evenly.
- 6—Fasten partitions by using one $\frac{7}{8}$ inch brad at each end.

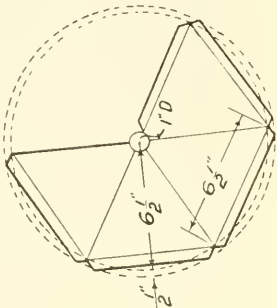


Fig. 15. Ripsawing on a Saw Horse.

Fly Trap



Pattern for Screen



*Lay out whole pattern
Cut on heavy lines
Fold on light lines*

FLY TRAP

Material Required

- Lumber: 1 piece white pine, cypress or basswood $\frac{1}{8}$ "x8x24 inches.
 1 piece white pine or basswood $\frac{1}{2}$ "x1 $\frac{1}{2}$ "x36 inches.
- Hardware: 16 flat head bright wood screws 1 $\frac{1}{2}$ inch, No. 8.
 4 dozen carpet tacks.
 1 piece wire fly screen 14 inches square.
 16 brads 1 $\frac{1}{4}$ inch, No. 18.
 14 shingle nails.

Tools

Sharp lead pencil, rule, try square, jack plane, handy saw, brace and $\frac{5}{16}$ inch twist drill, countersink, screw driver, hammer, nail set, compass.

Stock Bill

Pieces	Finished Dimensions	Use
4	$\frac{3}{4}$ "x $\frac{3}{4}$ "x8 $\frac{3}{4}$ inches.	Corners.
8	$\frac{3}{4}$ "x $\frac{3}{4}$ "x6 $\frac{1}{2}$ inches.	Cross Pieces.
2	$\frac{3}{4}$ "x $\frac{3}{4}$ "x9 $\frac{1}{2}$ inches.	Top.
2	$\frac{3}{4}$ "x $\frac{3}{4}$ "x8 inches.	Top.
2	$\frac{1}{2}$ "x1 x9 $\frac{1}{2}$ inches.	Top.
2	$\frac{1}{2}$ "x1 x7 $\frac{1}{2}$ inches.	Top.

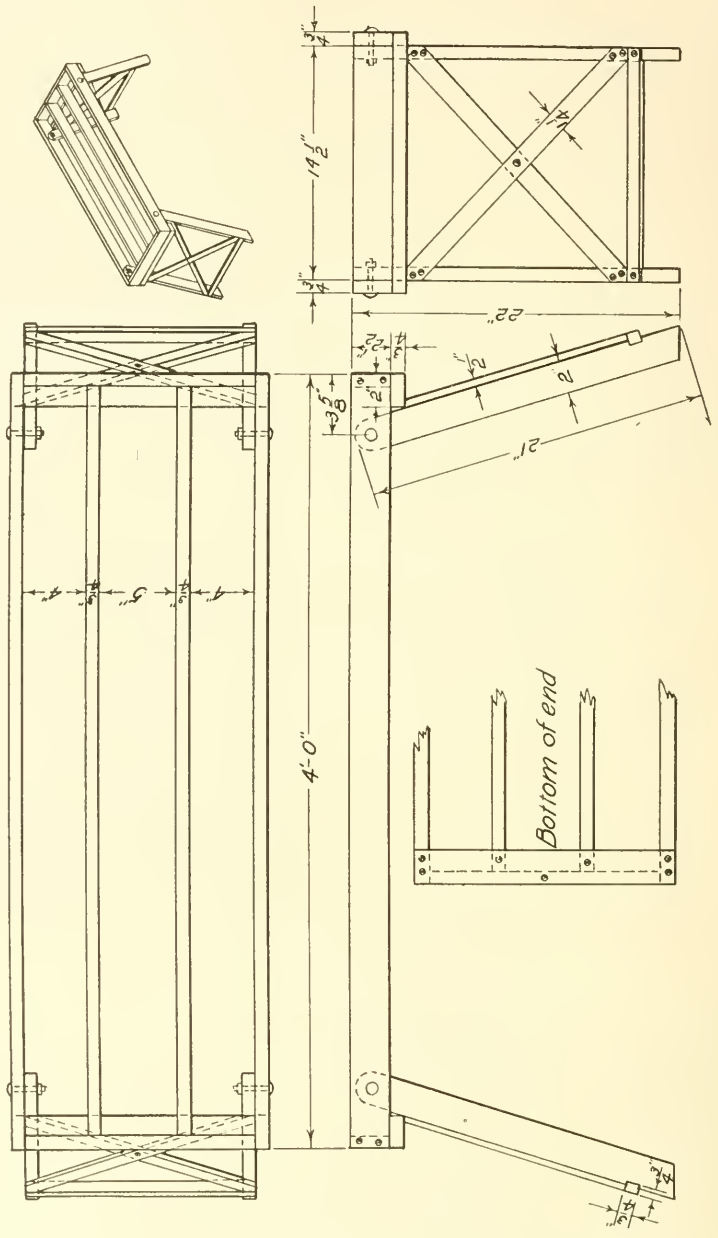


Fig. 16. Cross Sawing on a Saw Horse.

Directions

- 1—Reduce all pieces to finished dimensions.
- 2—Assemble box part of trap by using one flat head screw 1 $\frac{1}{2}$ inch No. 8, and one brad 1 $\frac{1}{4}$ inch No. 16 at each joint. The hole for the screw should be made about half the length of the screw with the 5-32 inch twist drill and then countersunk. The two screws at each corner must be placed a little above and below center respectively so as not to strike each other.
- 3—Place a brad at each joint at least $\frac{1}{4}$ inch from the screw so as to prevent the stock from turning.
- 4—Assemble the four $\frac{3}{4}$ inch pieces for the top same as box and nail the 1 inch strip as shown in the drawing with shingle nails.
- 5—Lay out the pattern for the screen on any piece of paper and cut the screen to the pattern with scissors or knife.
- 6—Sew the pattern together at the joint with a wire torn from the edge of the screen.
- 7—Tack screen in place with carpet tacks.

Folding Bench



FOLDING BENCH

Material Required

- Lumber: 1 piece cypress or white pine $\frac{1\frac{3}{8}}{8}$ x8 inches x 9 ft. 6 inches.
 1 piece cypress or white pine $\frac{1}{2}$ x1 $\frac{1}{4}$ inches x 7 feet.
 (Oregon pine or Southern pine may be substituted for cypress or white pine.)
- Hardware: 30 flat head bright wood screws 1 $\frac{3}{4}$ inches, No. 10.
 16 flat head bright wood screws 1 inch, No. 7.
 4 carriage bolts and washers $\frac{3}{8}$ x2 inches.

Tools

Sharp lead pencil, rule, try square, jack plane, handy saw, brace, $\frac{3}{8}$ inch bit, $\frac{3}{16}$ inch and $\frac{1}{8}$ inch twist drills, countersink, $\frac{3}{4}$ inch chisel, rip saw, screw driver, pliers, dividers.

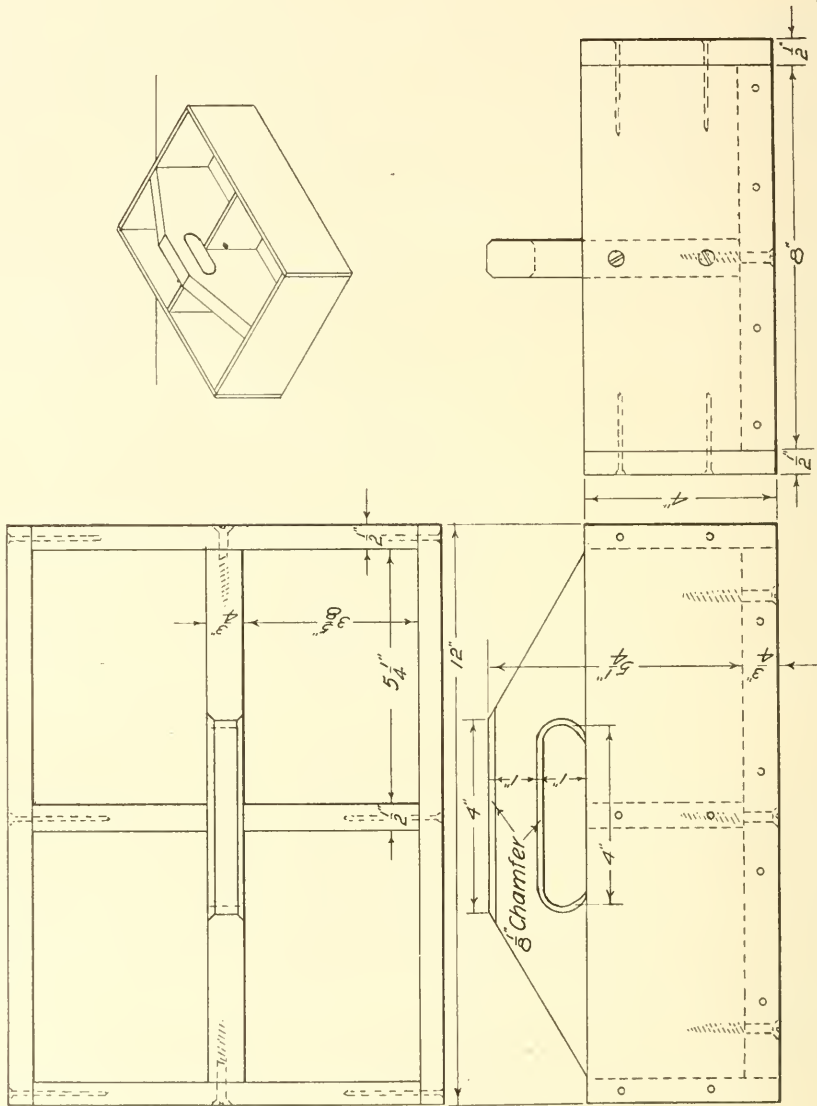
Stock Bill

Pieces	Finished Dimensions.	Use.
2.	$\frac{3}{4}$ x2 $\frac{1}{2}$ x 4 feet 0 inches.	Sides.
2.	$\frac{3}{4}$ x2 $\frac{1}{2}$ x 3 feet 10 $\frac{1}{2}$ inches.	Platform.
2.	$\frac{3}{4}$ x2 $\frac{1}{2}$ x14 $\frac{1}{2}$ inches.	Ends.
4.	$\frac{3}{4}$ x2 x21 inches.	Legs.
2.	$\frac{3}{4}$ x2 x16 inches.	End cross pieces.
2.	$\frac{3}{4}$ x $\frac{3}{4}$ x14 $\frac{1}{2}$ inches.	Lower cross pieces.
4.	$\frac{1}{2}$ x1 x21 inches.	End braces.

Directions

- 1—Reduce all pieces to finished dimensions.
- 2—Fasten ends to four long pieces by using two 1 $\frac{3}{4}$ inch No. 10 screws at each joint. Bore holes for screws with $\frac{3}{16}$ inch twist bit and countersink holes.
- 3—Fasten end lower cross piece by placing five screws as shown in the drawing.
- 4—Locate points for bolts on side pieces 1 $\frac{1}{8}$ inches from top edge and 3 $\frac{5}{8}$ inches from end and bore hole with $\frac{3}{8}$ inch bit.
- 5—Round upper end of legs.
- 6—Bore $\frac{3}{8}$ inch holes in legs at end for bolts.
- 7—Cut notch $\frac{1}{4}$ inch deep and $\frac{3}{4}$ inch wide in upper edge of legs 2 inches from end and fasten cross piece in place with one 1 $\frac{3}{4}$ inch screw at each joint.
- 8—Lay out cross braces, making half lap joint at center and fasten with two 1 inch No. 7 screws at each joint, and one $\frac{3}{8}$ inch screw at half lap joint.
- 9—Fasten legs to top with bolts.

Nail and Staple Box



NAIL AND STAPLE BOX

Material Required

- Lumber: 1 piece white pine or basswood $\frac{3}{8} \times 8 \frac{1}{4} \times 11 \frac{1}{2}$ inches.
 1 piece white pine or basswood $\frac{3}{8} \times 5 \frac{1}{2} \times 11 \frac{1}{2}$ inches.
 1 piece white pine or basswood $\frac{1}{2} \times 4$ inches by 4 feet 2 inches.
 (Redwood, poplar or eypress may be substituted for white pine or basswood.)
- Hardware: 5 flat head bright wood screws $1 \frac{1}{2}$ inches, No. 8.
 3 dozen 4d finishing nails.

Tools

- Sharp lead pencil, rule, try square, jack plane, handy saw, brace and 5-32 inch twist drill, countersink, 1 inch bit, screw driver, hammer, $\frac{3}{4}$ inch chisel.

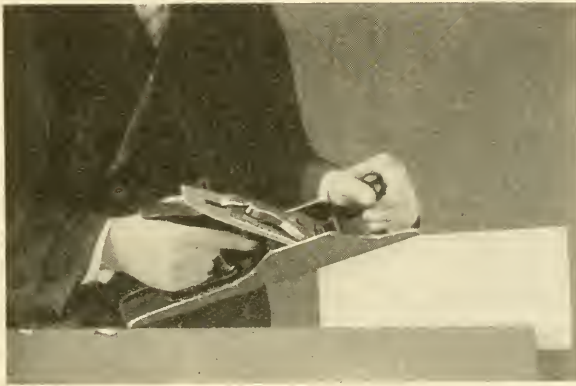


Fig. 17. Holding the Plane at an Angle to Cut a Chamfer

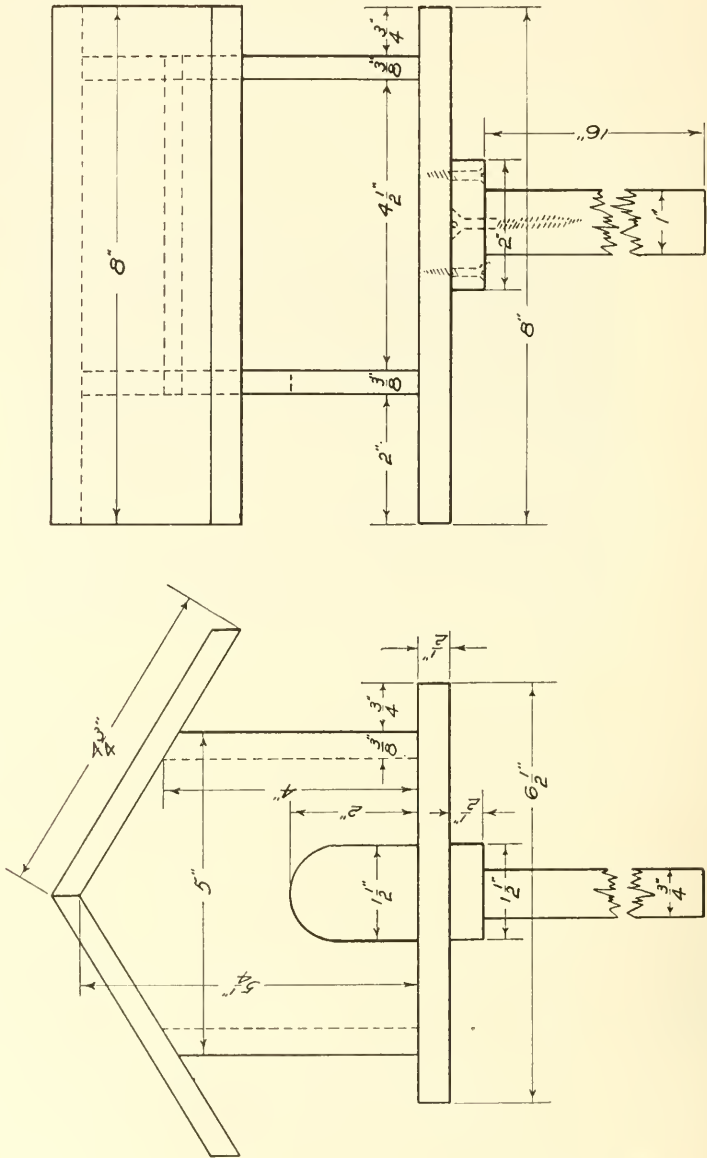
Stock Bill

Pieces.	Finished Dimensions.	Use.
1.	$\frac{3}{4} \times 8 \times 11$ inches.	Bottom.
1.	$\frac{3}{4} \times 5 \frac{1}{4} \times 11$ inches.	Partition and handle.
2.	$\frac{1}{2} \times 4 \times 12$ inches.	Sides.
2.	$\frac{1}{2} \times 4 \times 8$ inches.	Ends.
2.	$\frac{1}{2} \times 3 \frac{1}{4} \times 3 \frac{5}{8}$ inches.	Cross partitions.

Directions

- 1—Reduce all pieces to finished dimensions.
- 2—To lay out opening for hand draw a line lengthwise of stock $1 \frac{1}{2}$ inches from upper edge, also draw a center line crosswise of stock. Measurements should be made on line running lengthwise of stock from center line. Locate points on line $1 \frac{1}{2}$ inches from center line and bore 1 inch holes. Remove as much as possible of the remaining stock with 1 inch bit and trim opening with $\frac{3}{4}$ inch chisel.
- 3—In making partition and handle first reduce piece to $\frac{3}{4} \times 5 \frac{1}{4} \times 11$ inches. To lay out the slant draw two lines across upper edge $3 \frac{1}{2}$ inches from ends and a line across each end 2 inches from upper edge. Connect lines just drawn with lines on both sides.
- 4—Lay out $\frac{1}{8}$ inch chamfer on upper edge and both ends of opening with pencil and remove stock with chisel.
- 5—Remove stock for slant with saw and trim to line with plane.
- 6—Lay out $\frac{1}{8}$ inch chamfer on corners of upper edge and remove stock with plane.
- 7—Assemble box by placing nails and screws as shown in drawing.

Bird House



BIRD HOUSE

Material Required

- Lumber:** 1 piece white pine or basswood $\frac{3}{8} \times 5 \frac{1}{4}$ inches x 3 feet 2 inches.
 1 piece white pine or basswood $\frac{1}{2} \times 8 \frac{1}{4} \times 8 \frac{1}{2}$ inches.
 1 piece white pine or basswood $\frac{3}{8} \times 1 \frac{1}{8} \times 16 \frac{1}{2}$ inches.
 (Poplar, cypress or redwood may be substituted for pine or basswood.)
- Hardware:** 1 flat head bright wood screw 2 inch No. 12.
 4 flat head bright wood screws $\frac{7}{8}$ inch No. 7.
 1 dozen $1 \frac{1}{4}$ inch brads No. 18.
 2 dozen 1 inch brads No. 18.

Tools

Sharp lead pencil, rule, try square, jack plane, handy saw, brace, coping saw, twist drills 7-32 inch and $\frac{1}{8}$ inch, countersink, screw driver, hammer, nail set, T bevel.

Stock Bill

Pieces.	Finished Dimensions.	Use.
1.	$\frac{1}{2} \times 6 \frac{1}{2} \times 8$ inches.	Bottom.
2.	$\frac{3}{8} \times 5$ x $5 \frac{1}{4}$ inches.	Ends.
2.	$\frac{3}{8} \times 4 \frac{1}{2} \times 4$ inches.	Sides.
2.	$\frac{3}{8} \times 4 \frac{3}{4} \times 8$ inches.	Roof.
1.	$\frac{1}{2} \times 1 \frac{1}{2} \times 2$ inches.	Brace.
1.	$\frac{3}{4} \times 1$ x 16 inches.	Post.

Directions

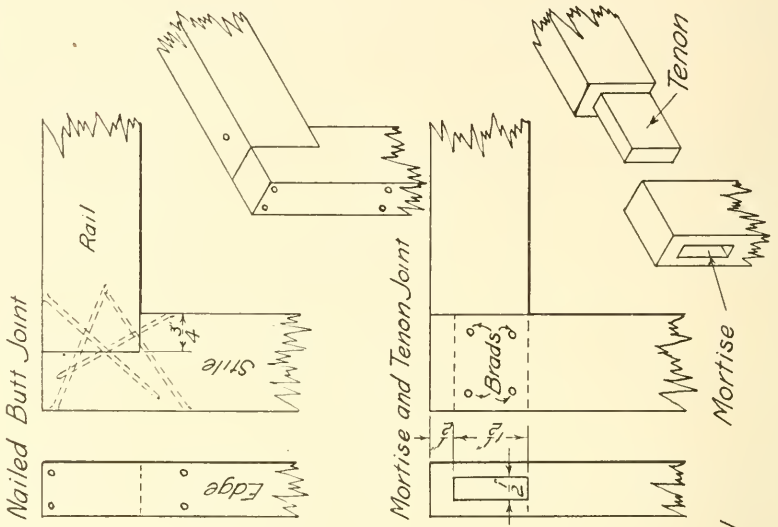
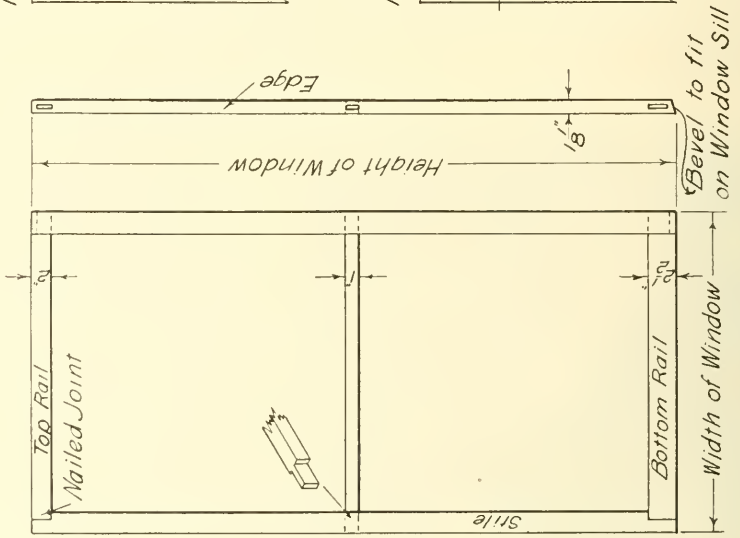
- 1—Reduce all pieces to finished dimensions.
- 2—To make doorway draw a center line lengthwise of end piece and swing a circle with compass using point on center line $1 \frac{1}{4}$ inches from end as center.
- 3—Draw lines at right angle to end tangent to sides of circle.
- 4—Remove stock for doorway using handy saw to cut to circle and coping saw to make the circle.



Fig. 18. Setting Nail with Nail Set.

- 5—Set the T bevel at the same angle as shown in the drawing and lay out the slant for the gable of end pieces.
- 6—With T bevel in same position as for gables lay out bevels on upper edge of both sides and both edges of two pieces for roof.
- 7—Fasten brace to post with 2 inch No. 12 screw. Holes for flat head screws should always be bored and countersunk.
- 8—Fasten brace and post to bottom with four $\frac{7}{8}$ inch No. 7 screws as shown in drawing.
- 9—Nail ends to sides by using three 1 inch brads at each joint.
- 10—Draw lines on lower side of bottom piece where brads are to be placed so that when driven through bottom they will enter sides and ends.
- 11—Nail bottom, ends and sides by using three 1 inch brads at each side and back and two at front.
- 12—Fasten top in place by using seven 1 inch brads for each side.
- 13—Set brads with nail set.

Window Screen



WINDOW SCREEN

Material Required for Each Window

Lumber: 1 piece white pine or cypress $1\frac{1}{8} \times 2\frac{1}{2}$ inches by width of window for bottom rail.
 1 piece white pine $1\frac{1}{8} \times 2$ inches by width of window plus twice the length of window for top rails and stiles.
 1 piece white pine $1\frac{1}{8} \times 1$ inch by width of window for middle rail.
 Enough screen moulding to cover edges of screen and middle rail.

Hardware: Twenty 10d casing nails, if nailed joint is used; 1 package No. 16 brads if mortise and tenon joint is used and for nailing moulding; package of carpet tacks for screen; wire fly screen; paint.

The finished dimensions are not given here as they must be obtained by measuring the window where the screen is to fit.

The mortise and tenon joint is the stronger and better way of joining the screen at the corners, yet a nailed joint holds the members firmly in place if the



Fig. 19. Position of Chisel and Mallet for Mortising.



Fig. 20. Method for Holding Chisel in Mortising.

nails are well placed at an angle as shown in the drawing. The screen need lap only far enough on the sides and ends to be securely nailed. It should not project outside of the moulding which is placed on the inside edge of the sides and ends and across the middle rail.

The painting should be done carefully so as to prevent moisture from getting into the joints.

TOOL SHARPENING

There are three distinct operations in sharpening a plane bit or chisel; first, grinding, Fig. 21; second, whetting the beveled side, Fig. 22; third, removing the wire edge from the plain side, Fig. 23.

In grinding a plane iron loosen the cap screw with a screw driver and set the lever cap back on the plane iron so that it will be out of the way when removing the wire edge from the plain side.



Fig. 21. Grinding a Chisel.

In whetting the beveled side of the chisel or plane iron it should be held firmly in both hands as indicated in Fig. 22 and given three or four forward strokes, pressing the iron firmly on to the stone. Do not move the wrists for this motion. The movement should occur at the elbow and by the swaying of the body forward and back.



Fig. 22. Whetting the Beveled Side of a Chisel.



Fig. 23. Removing the Wire Edge from the Plain Side of a Chisel.

The plane iron or cutter should be held on the grinder so that the edge will be a perfect right angle with the side. It should be held firmly in one position so that only one bevel will be formed. In grinding, the tool should be moved from side to side on the grinder so as to prevent wearing the stone unevenly.

To remove the wire edge, lay the flat side of chisel or plane iron, flat on the oil stone as shown in Fig. 23 and move it back and forth three or four strokes. Under no circumstances should the end of the iron be raised or lowered so that it won't lie flat on the stone.

Until one becomes thoroughly familiar with tool sharpening the whetting of both beveled and plain sides may need to be done more than once to insure a good cutting tool.

SAW FILING

The first operation in sharpening a saw is that of jointing the saw, Fig. 24. The purpose of this is to bring all teeth to an even length. This is done by drawing a flat file across the teeth of the saw. One or two strokes is usually sufficient. The file must be held perfectly square; this may be facilitated by use of a block called a saw jointer, as shown in Fig. 24.

The second operation in saw sharpening is that of setting the saw. This consists of bending the teeth outward, one on one side, the next on the other and so on till all the teeth are bent. The set should not extend more than half the length of the tooth. For ordinary work the teeth should be set about one-third the thickness of the blade. For dry lumber the saw will require less set than for green or wet lumber.



Fig. 24. Jointing a Saw.

The third operation is that of filing the saw. In filing a cross-cut saw the point of the file should point toward the point of the saw at an angle of about 45 degrees. In filing a rip saw the file is held straight across the saw. File every tooth to a point, one-half of the filing being done from each side, being careful to stop filing a tooth when it has been brought to a point. File the entire length of the saw from one side, then reverse the saw and file from the other side. The front edge of each tooth projecting away from the filer and the back edge of the tooth next ahead, should be filed with the same stroke. Only forward strokes of the file should be used.

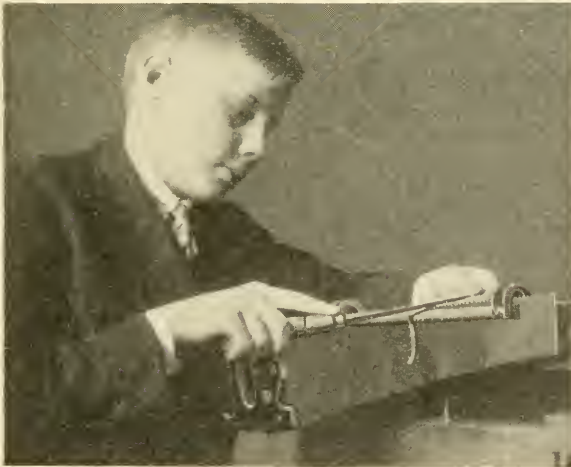
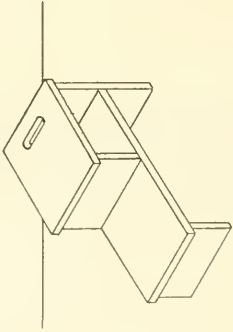
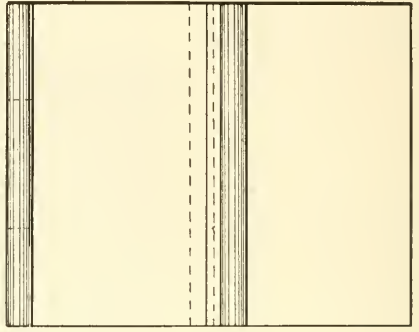
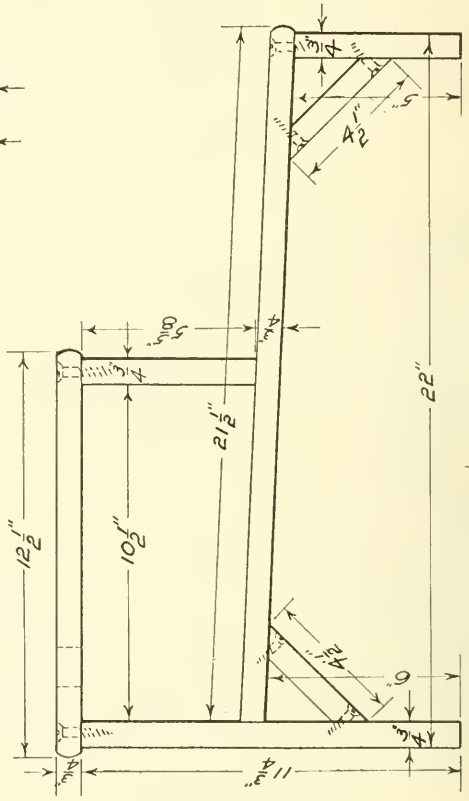
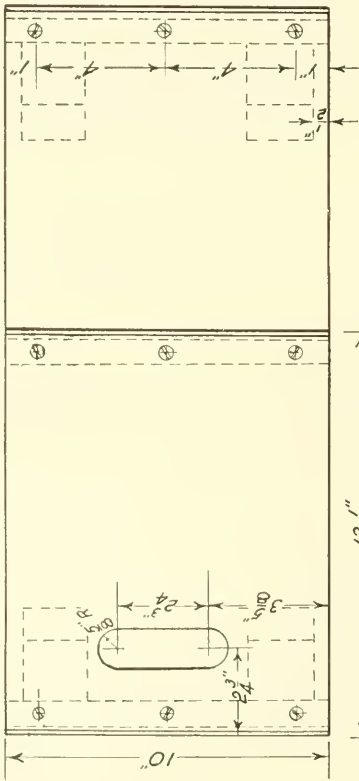


Fig. 25. Filing a Saw.

The fourth operation consists of placing the saw flat on a smooth surface, as the top of a bench, and running a whetstone over the teeth so as to remove the burr from the teeth caused by filing.

Milking Stool



MILKING STOOL

Material Required

Lumber: 1 piece white pine $\frac{3}{8}$ "x10"x5' 3".

(Cypress or redwood may be substituted for white pine.)

Hardware: 15 flat head bright wood screws, $1\frac{3}{4}$ " No. 10. 16 flat head bright wood screws, $1\frac{1}{4}$ " No. 8 for braces.

Stock Bill

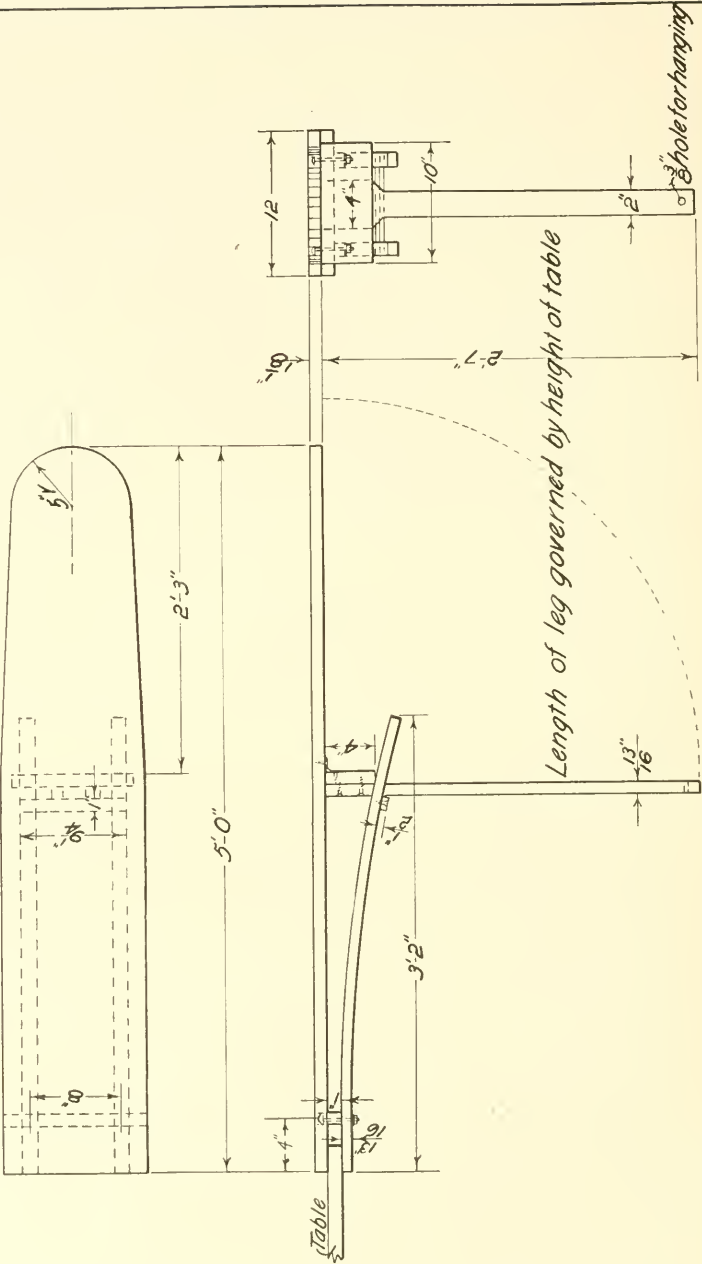
Pieces.	Finished Dimensions.	Use.
1.	$\frac{3}{4}$ "x10"x12 $\frac{1}{2}$ "	Seat.
1.	$\frac{3}{4}$ "x10"x11 $\frac{3}{4}$ "	Back Leg.
1.	$\frac{3}{4}$ "x10"x5"	Front Leg.
1.	$\frac{3}{4}$ "x10"x21 $\frac{1}{2}$ "	Pail Rest.
1.	$\frac{3}{4}$ "x10"x5 $\frac{5}{8}$ "	Front Seat Support.
4.	$\frac{3}{4}$ "x 2"x4 $\frac{1}{2}$ "	Braces.

Directions

1. Reduce all pieces to finished dimensions.
2. Round both ends of the seat and the front end of the pail rest to lines drawn across the stock on both sides $\frac{1}{8}$ " from the end.
3. Locate points on seat for hand hole as shown in the drawing and at these points swing circles with $\frac{5}{8}$ " radius. Draw lines tangent to the circles.
4. Bore a hole with $\frac{1}{2}$ " bit so that the outside of the $\frac{1}{2}$ " hole touches the outside edge of the circle and cut the opening with a coping saw.
5. Set the T bevel for the bevel cuts at the back end of the pail rest, the lower end of the front seat support, the upper end of the front leg and the upper end of the braces from the drawing and cut ends to the bevels. The lower ends of the braces are 45 degree cuts and may be laid out by setting the T bevel at 45 degrees on the steel square.
6. Bore three holes for $1\frac{3}{4}$ " No. 10 screws at each joint spaced as shown in the drawing with 3-16" wood twist drill; countersink the holes and assemble the parts.
7. Bore 5-32" holes for screws in braces; countersink the holes and fasten the braces.

The stool may be assembled by using four 6d common nails at each joint and two 6d common nails at each end of each brace; however the screws are a better form of construction.

Ironing Board



IRONING BOARD

Material Required

- Lumber: 1 piece white pine, poplar or basswood, $1\frac{1}{8}'' \times 12'' \times 5' 0''$.
 1 piece white pine, poplar or basswood, $\frac{1}{8}'' \times 4'' \times 3' 6''$.
 1 piece birch or oak $\frac{1}{8}'' \times 1\frac{1}{4}'' \times 8' 4''$.
 Hardware: 2 carriage bolts $\frac{1}{4}'' \times 2\frac{1}{2}''$ with 2 washers each.
 4 flat head bright wood screws $1\frac{1}{4}''$, No. 8.
 2 flat head bright wood screws $\frac{7}{8}''$, No. 7.
 2 steel butt hinges, riveted, with $1\frac{1}{8}''$ screws.

Stock Bill

Pieces.	Finished Dimensions	Use.
1.	$1\frac{1}{8}'' \times 12'' \times 5' 0''$	Board.
2.	$\frac{1}{8}'' \times 1\frac{1}{4}'' \times 3' 2''$	Clamps.
1.	$\frac{1}{8}'' \times 1'' \times 12''$	Parting Strip.
1.	$\frac{1}{2}'' \times 1'' \times 9\frac{1}{4}''$	Cross bar.
1.	$\frac{1}{8}'' \times 4'' \times 2' 7''$	Post.
1.	$\frac{1}{8}'' \times 4'' \times 10''$	Post and Hinge Support.

Directions

1. Reduce all pieces to finished dimensions.
2. To shape the board draw a center line lengthwise of stock and swing an arc with $5''$ radius on center line $5''$ from end.
3. Draw lines across both edges $2' 3''$ from the same end as the arc.
4. Remove stock to line with saw, draw knife and plane.
5. Locate points for bolts $4''$ from end and $2''$ from edge and bore a $11-16''$ hole $\frac{1}{2}''$ deep on the upper edge of board.
6. Bore $\frac{1}{4}''$ holes thru the board in center of $11-16''$ holes, and thru the parting strips and clamps.
7. Bolt these three members in place and plug the $11-16''$ holes.
8. Fasten the post to the post and hinge support with four $1\frac{1}{4}''$ No. 8 screws.
9. Cut a small groove in the lower side of the board and also in the edge of the post and hinge support for the joint of the hinges and fasten the hinges.
10. Place the board on the bench and the post standing up at right angle to the board and fasten the cross bar to the clamps so that it touches the post.
11. Bore the $\frac{3}{8}''$ hole in the lower end of post for hanging the board.

WAGON JACK

Material Required

Lumber: 1 piece oak, birch, maple or other hardwood 1"x6"x6' 6".
 Hardware: 6 machine bolts $\frac{3}{8}$ "x3 $\frac{1}{2}$ " with washers.
 2 flat head, bright wood screws 1 $\frac{1}{2}$ ", No. 10.
 2 pieces of iron $\frac{1}{4}$ "x1"x4".
 3 iron rivets $\frac{1}{4}$ "x1 $\frac{3}{4}$ ".

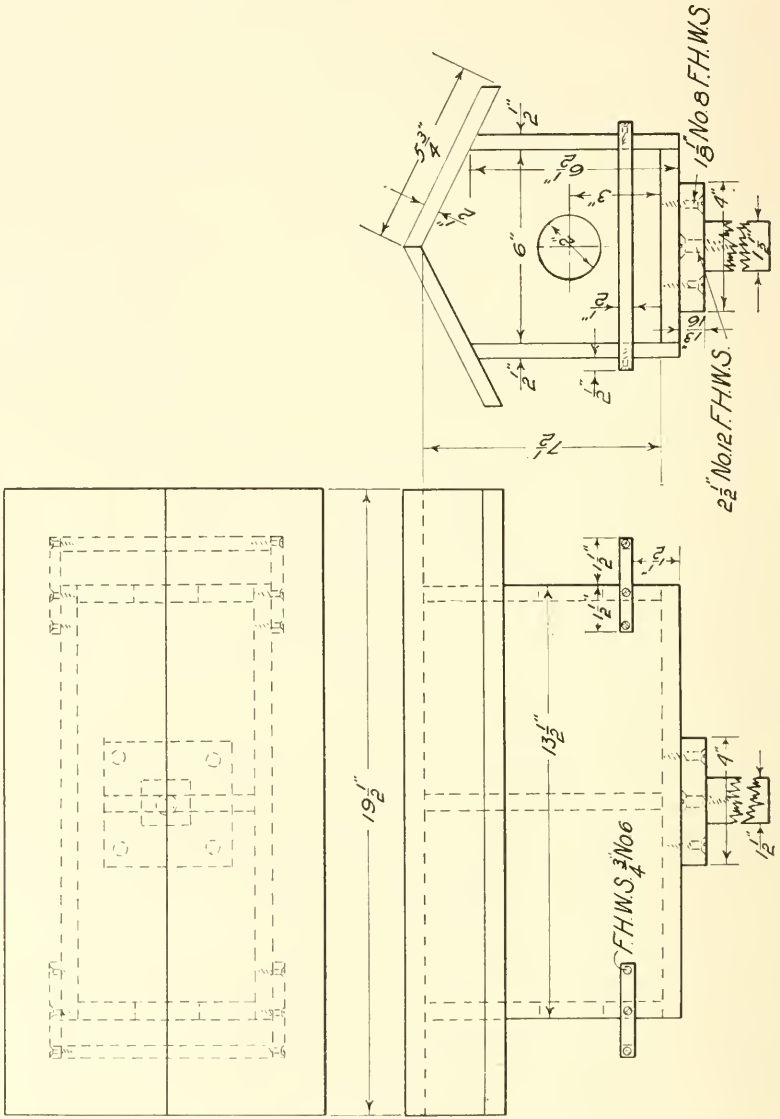
Stock Bill

Pieces.	Finished Dimensions	Use
1.	1"x3"x3'-0"	Top.
1.	1"x2 $\frac{1}{2}$ "x3'-0"	Main Brace.
2.	1"x2 $\frac{1}{4}$ "x12"	Front Standards.
2.	1"x1 $\frac{1}{8}$ "x22"	Back Standards.
1.	1"x3"x24"	Lever.
1.	$\frac{3}{4}$ "x2"x8"	Foot.
1.	$\frac{7}{8}$ "x4"x4"	Wheel.

Directions

1. Reduce all pieces to finished dimensions.
2. Round one end of the top by swinging an arc on a centerline at one end with a radius of one and one-half inches, and remove stock with saw and chisel.
3. Lay out axle notches by drawing lines across the upper edge of the top two and three-quarters inches apart, and another line on the side of the stock one inch from the top edge. Cut the notches with the rip and cross-cut saws.
4. Round the ends of the front standards by swinging arcs on a centerline one and one-eighth inches from the end with a one and one-eighth inch radius.
5. Find the center of the piece for the wheel by drawing lines diagonally across the stock, and swing the circle with the compass set at a 2 inch radius.
6. Lay out the lower end of the main brace as shown in the detail drawing to fit the foot, and cut the upper end at a bevel.
7. Lay out and cut a one-quarter inch chamfer around the upper edge of the foot excepting where it fits into the main brace.
8. Swing a circle on a centerline drawn lengthwise of the lever, one and one-half inches from the upper end with the compass set at one and one-half inch radius; taper the lever to one and one-half inches at the lower end, and remove the stock to line. Lay out and cut a one-quarter inch chamfer at all four corners of the lever as shown in the drawing.
9. Fasten the foot to the main brace with two one and one-half inch No. 10 flat head, bright wood screws.
10. Bore holes with three-eighths inch bit for bolts at positions shown in the drawing and assemble parts with bolts.
11. Bore one-quarter inch holes for rivets of iron plate at center of circle of lever, as shown in the drawing at upper end, and fasten plates by riveting in position.

Community Bird House



COMMUNITY BIRD HOUSE

Material Required

Lumber: 1 piece white pine or basswood $\frac{1}{2}$ "x6 $\frac{1}{2}$ "x9' 4".

1 piece white pine or basswood $\frac{1}{8}$ "x4"x4".

1 piece white pine or basswood 1 $\frac{1}{2}$ "x1 $\frac{1}{2}$ "x16".

(Poplar, cypress or redwood may be substituted for white pine or basswood.)

Hardware: 1 flat head bright wood screw 2 $\frac{1}{2}$ ", No. 12.

4 flat head bright wood screws 1 $\frac{1}{8}$ ", No. 8.

2 $\frac{1}{2}$ doz. brads 1 $\frac{1}{4}$ ", No. 18, for bottom and sides.

1 $\frac{1}{2}$ doz. 6d finishing nails for roof.

Stock Bill

Pieces.	Finished Dimensions.	Use.
1.	$\frac{1}{2}$ "x6"x13 $\frac{1}{2}$ "	Bottom.
2.	$\frac{1}{2}$ "x6 $\frac{1}{2}$ "x13 $\frac{1}{2}$ "	Sides.
3.	$\frac{1}{2}$ "x6"x7 $\frac{1}{2}$ "	Ends and partition.
2.	$\frac{1}{2}$ "x5 $\frac{3}{4}$ "x19 $\frac{1}{2}$ "	Roof.
1.	$\frac{1}{8}$ "x4"x4"	Support for post.
1.	1 $\frac{1}{2}$ 'x'1 $\frac{1}{2}$ "x16"	Post
2.	$\frac{1}{2}$ "x $\frac{1}{2}$ "x7"	Perch
4.	$\frac{1}{2}$ "x $\frac{1}{2}$ "x3"	Perch supports.

Directions

1. Reduce all pieces to finished dimensions.

2. To make doorway locate a point for center as indicated in drawing and draw a circle with the compass. Bore a hole with $\frac{1}{4}$ " bit so that the outside edge of the hole touches the circle. Place a coping saw blade thru the $\frac{1}{4}$ " hole, fasten blade in frame and saw the circle.

3. To lay out the slant on partition and end pieces for gable set the T bevel at the same position as shown in the drawing.

4. Lay out the bevels at ridge and eaves of roof boards with T bevel set the same as for end pieces.

5. Fasten brace to post with one flat head bright wood screw 2 $\frac{1}{2}$ ", No. 12.

6. Drill holes for screws with 5-32" wood twist drill $\frac{1}{2}$ " from end and $\frac{1}{2}$ " from side at each corner of brace and fasten brace and post to bottom with four flat head bright wood screws 1 $\frac{1}{4}$ ", No. 8.

7. Fasten ends and partition to bottom with four 1 $\frac{1}{4}$ " No. 18 brads at each joint.

8. Fasten sides to ends and partition by using five brads on each side at the bottom and three at each end.

9. Fasten roof by using three 6d finishing nails at each joint. All nails and brads should be spaced evenly and driven straight so as not to run out at the side.

10. In boring the holes for the $\frac{3}{4}$ " screws in the perch supports the wood should be clamped in the vise so as to prevent splitting.

11. Fasten perches with $\frac{3}{4}$ " No. 6 flat head bright wood screws as shown in the drawing.

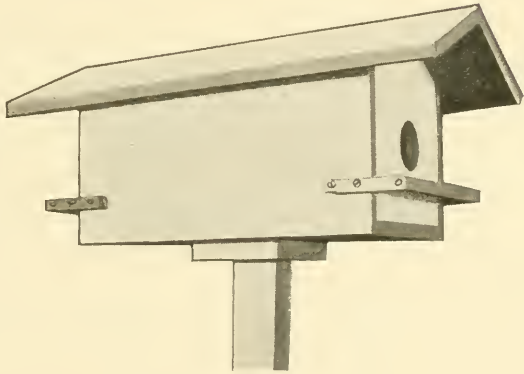
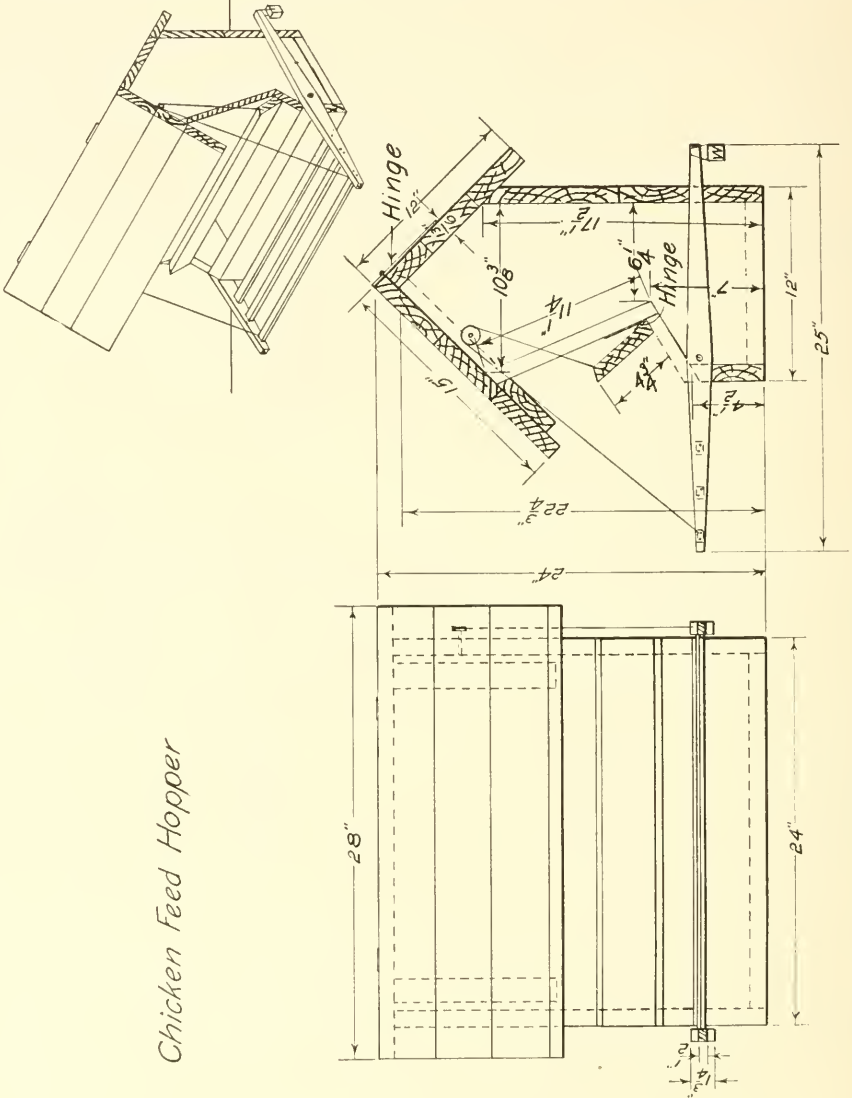


Fig. 26. Community Bird House.

Chicken Feed Hopper



CHICKEN FEED HOPPER

Material Required

- Lumber: 2 pieces white pine 1"x12"x12' 0".
 Redwood or cypress may be substituted for white pine.
 Hardware: $\frac{1}{2}$ lb. 8d common nails.
 1 round-head blued wood screw 1 $\frac{1}{4}$ " No. 10.
 2 round-head blued wood screws 1 $\frac{3}{4}$ " No. 10.
 1 doz. 6d common nails.
 1 doz. 6d finishing nails.
 2 pair 6" light T hinges.
 32" of heavy cord.
 Small piece of wire for fastening weight.
 2 small screw eyes for fastening cord.

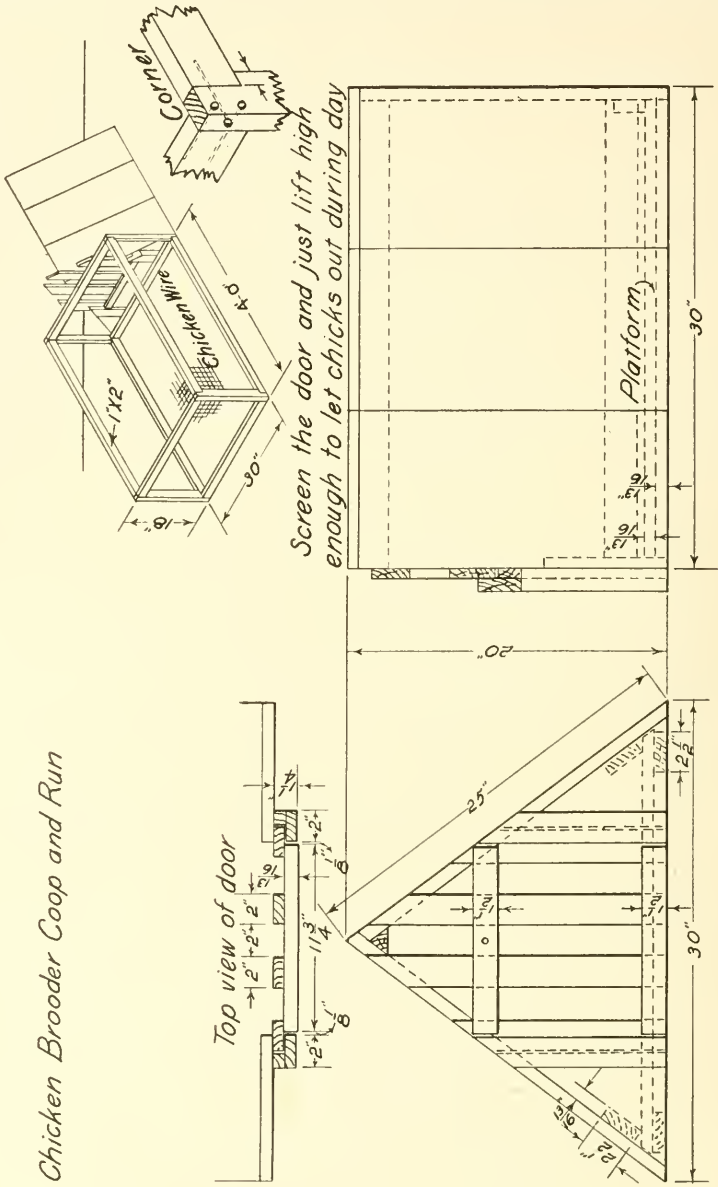
Stock Bill

Pieces.	Finished Dimensions	Use.	Pieces.	Finished Dimensions.	Use.
1.	$\frac{13}{16}$ "x10 $\frac{3}{8}$ "x22 $\frac{3}{8}$ "	Bottom.	1.	$\frac{13}{16}$ "x7"x2' 4"	Top door.
2.	$\frac{13}{16}$ "x10 $\frac{3}{8}$ "x22 $\frac{3}{4}$ "	Ends.	1.	$\frac{13}{16}$ "x8"x2' 4"	Top door.
2.	$\frac{13}{16}$ "x8 $\frac{3}{4}$ "x24"	Back.	2.	$\frac{13}{16}$ "x2"x13"	Cleats for door.
1.	$\frac{13}{16}$ "x4 $\frac{1}{2}$ "x24"	Front at bottom	2.	$\frac{13}{16}$ "x1 $\frac{3}{4}$ "x2' 1"	Levers.
1.	$\frac{13}{16}$ "x11 $\frac{3}{4}$ "x24"	Front.	3.	$\frac{1}{2}$ "x1 $\frac{1}{8}$ "x24 $\frac{1}{4}$ "	Perches.
1.	$\frac{13}{16}$ "x4 $\frac{3}{4}$ "x24"	Door.	1.	$\frac{1}{2}$ "x2" D. Circle	Pulley.
1.	$\frac{13}{16}$ "x11 $\frac{3}{16}$ "x2' 4"	Top.			

Directions

- Reduce all pieces to finished dimensions.
- Nail the ends to the bottom by using three nails at each joint.
- Nail the boards for the back in place and bevel the upper edge of the upper board so that the roof will fit on it snugly.
- Bevel the lower edge of the front board to fit against the end boards; fasten with three nails at each end and bevel the upper edge same as upper edge of back.
- Nail the front board at bottom and bevel its upper edge.
- Fasten the top by driving two nails into each end board and four into the back.
- Nail the cleats to the door using at least six 6d common nails for each cleat. The nails should be driven at a slant so as not to come thru.
- Cut notches in the upper edges of front to receive the cleats when the door is closed.
- Fasten hinges to door and door to top.
- Bevel the top edge of the lower door to fit front; fasten door by placing the strap part of the hinges against the box and bevel the front edge of the door.
- Fasten the three perches to the lever, by driving two 6d finishing nails thru the lever into each end.
- Place the levers driving a one and three-quarter inch, No. 10 round-head blued wood screw thru its center, and into the end of the hopper at points shown in the drawing.
- Fasten a screw eye into the upper edge of one lever at the front end, and another into the upper front edge of the lower door.
- Make a pulley for the cord by sawing a two-inch circle with the coping saw; cut a groove to receive the cord in the face of the pulley with round file or chisel. Bore a hole thru the center of the pully the size of a two-inch, No. 10 screw and fasten in position shown in drawing.
- Fasten cord to screw eyes and run over the pulley.
- Hang a weight at the back end of the levers of sufficient weight to lower the door.

Chicken Brooder Coop and Run



CHICKEN BROODER COOP AND RUN

Material Required

- Lumber:** 1 piece $\frac{13}{16}'' \times 9'' \times 10' 0''$ white pine, Oregon pine, cypress or redwood.
 1 piece $\frac{13}{16}'' \times 2\frac{1}{2}'' \times 10' 0''$ white pine, Oregon pine, cypress or redwood.
 1 piece $\frac{13}{16}'' \times 2'' \times 7' 6''$ white pine, Oregon pine, cypress or redwood.
 1 piece $\frac{13}{16}'' \times 1\frac{1}{2}'' \times 2' 0''$ white pine, Oregon pine, cypress or redwood.
 1 piece $\frac{7}{8}'' \times 1'' \times 2' 0''$ white pine, Oregon pine, cypress or redwood.
- Hardware:** $\frac{1}{4}$ lb. 4d common nails.
 1 lb. 6d common nails.
 21 lineal ft. 18'', 1'' mesh chicken wire.
 $\frac{1}{4}$ lb. $\frac{3}{4}''$ poultry netting staples.

Stock Bill

Pieces.	Finished Dimensions	Use.	Pieces.	Finished Dimensions	Use.
3.	$\frac{13}{16}'' \times 9'' \times 28\frac{3}{4}''$	Platform.	3.	$\frac{13}{16}'' \times 10'' \times 25''$	Roof.
4.	$\frac{13}{16}'' \times 2\frac{1}{2}'' \times 27''$	Cleats for bot- tom and sides.	3.	$\frac{13}{16}'' \times 10'' \times 24\frac{1}{4}''$	Roof.
2.	$\frac{13}{16}'' \times 2'' \times 19''$	Middle door slats.	1.	$\frac{13}{16}'' \times 10'' \times 20''$	Back.
2.	$\frac{13}{16}'' \times 2'' \times 13\frac{1}{2}''$	Side door slats.	2.	$\frac{13}{16}'' \times 9'' \times 18''$	Back.
2.	$\frac{13}{16}'' \times 2'' \times 12''$	Front piece of slot for door.	1.	$\frac{13}{16}'' \times 2\frac{1}{2}'' \times 23''$	Cleat for back. door.
2.	$\frac{7}{8}'' \times 1'' \times 11''$	Back piece of slot for door.	2.	$\frac{13}{16}'' \times 1\frac{1}{2}'' \times 11\frac{3}{4}''$	Cleats for door.
			4.	$\frac{13}{16}'' \times 2'' \times 3' 9''$	Run sides.
			4.	$\frac{13}{16}'' \times 2'' \times 2' 4\frac{3}{8}''$	Run ends.
			4.	$\frac{13}{16}'' \times 2'' \times 18''$	Run posts.

Directions

1. Reduce all pieces to finished dimensions and label each piece. Labels should be written neatly with letters about the size used in writing on paper. Careless writing does not look well on woodwork.

2. Fasten bottom cleats to bottom by driving two 6d common nails in each board at each end. The nails are longer than the thickness of the boards and should be driven at a slant so as not to go thru.

3. Fasten cleats to roof boards same as bottom and drive two nails into each board at the ridge.

4. For laying out the slant on upper end of pieces for back and front the T bevel should be used and may be set at the same angle as the drawing.

5. Fasten cleat to back pieces the same as bottom and roof; set back pieces in place and nail thru edge of back roof board.

6. Nail the two lower front pieces firmly in place by nailing thru edge of front roof board and one nail in end of roof board cleat.

7. Place cleats for door as shown in "Top view of door" and fasten with 6d nails.

8. Fasten cleats to door by using two 4d common nails at each joint. Take a few shavings from the side of the side pieces so the door may slide freely.

9. Cut the ends of the corner posts of the run as shown in the detail drawing and join the corners with three 6d common nails placed as shown in detail of corner. Assemble the sides and ends first.

10. In fastening the wire begin at one corner and run the wire around the run, cutting the opening for the door as wide as the door and eight inches high. Do not cut the bottom strand of wire. Staples should be placed not more than 6 inches apart.

11. Run the wire lengthwise at the top and fasten with staples at the end and sides.

12. Bore a $\frac{3}{8}$ inch hole thru the upper door cleat at the center. A peg placed in this hole may rest on the upper end piece of the run and hold the door open. A similar hole thru a slat of the door and into the front edge of the front roof board furnishes a place for the peg to hold the door open when the run is not in use. A brooder coop should be built so that the roof may be removed and the platform thoroly cleaned.

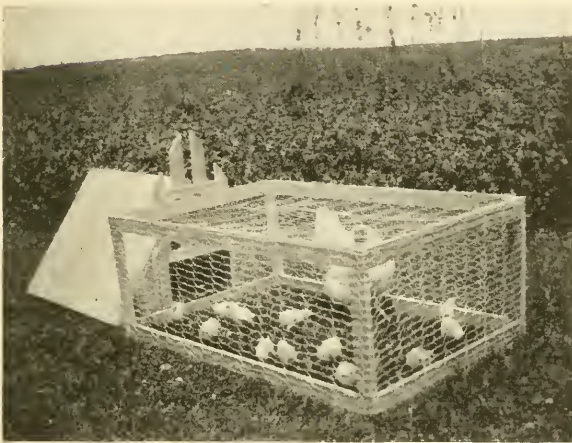
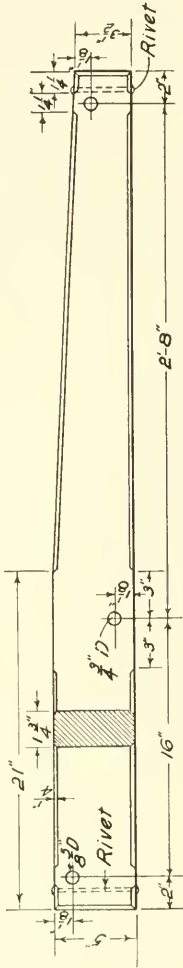
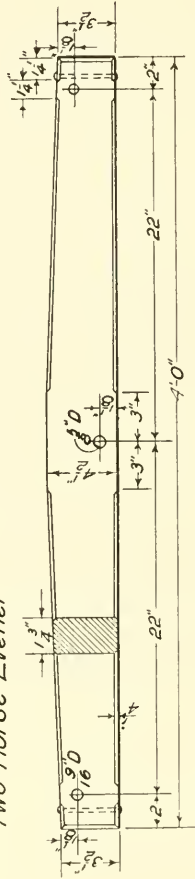


Fig. 27. Chicken Brooder Coop and Run.

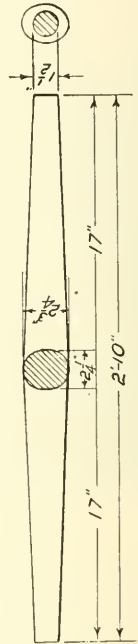
Three Horse Evener



Two Horse Evener



Singletree



Detail showing how to lay out end.

THREE-HORSE EVENER

Lumber: 1 piece select hickory $1\frac{3}{4}'' \times 5'' \times 4' 4''$. (If hickory is not available, white ash may be used.)

Hardware: 1 iron rivet $\frac{1}{4}'' \times 3\frac{3}{4}''$ with 2 washers.
1 iron rivet $\frac{1}{4}'' \times 5\frac{1}{4}''$ with 2 washers.

Directions

1. Reduce stock to $1\frac{3}{4}'' \times 5'' \times 4' 4''$.
2. Lay out the taper for the one-horse end by drawing a line from a point on the back edge of the stock 21'' from the two-horse end to a point on the one-horse end $3\frac{1}{2}''$ from the front edge.
3. Remove the stock to line with saw and plane.
4. Lay out and cut a $\frac{1}{4}''$ chamfer on the edges of the stock as indicated in the drawing.
5. Bore $\frac{1}{4}''$ holes for the rivets $1\frac{1}{4}''$ from ends and fasten rivets by securely riveting them.
6. Locate points 2'' from ends and $1\frac{1}{8}''$ from back edge of stock and bore $\frac{5}{8}''$ holes for clevises.
7. Locate a point 18'' from the two-horse end and $1\frac{1}{8}''$ from the front edge, and bore a $\frac{3}{4}''$ hole for main clevis pin.

TWO-HORSE EVENER

Lumber: 1 piece select hickory or ash $1\frac{3}{4}'' \times 4\frac{1}{2}'' \times 4' 0''$.

Hardware: 2 iron rivets $\frac{1}{4}'' \times 3\frac{3}{4}''$.

Directions

1. Reduce stock to $1\frac{3}{4}'' \times 4\frac{1}{2}'' \times 4' 0''$.
2. Lay out the taper by drawing lines across the back edge of the stock 21'' from each end and lines across both ends $3\frac{1}{2}''$ from the front edge and connecting the lines by lines drawn on the sides of the stock.
3. Remove the stock to line with the saw and plane.
4. Lay out and cut a $\frac{1}{4}''$ chamfer on the edges of the stock as indicated in the drawing.
5. Bore $\frac{1}{4}''$ holes for the rivets $1\frac{1}{4}''$ from ends and place rivets.
6. Locate points 2'' from ends and $1\frac{1}{8}''$ from back edge of stock and bore 9-16'' holes for clevises.
7. Locate a point 24'' from either end and $1\frac{1}{8}''$ from the front edge and bore a $\frac{5}{8}''$ hole for the main clevis pin.

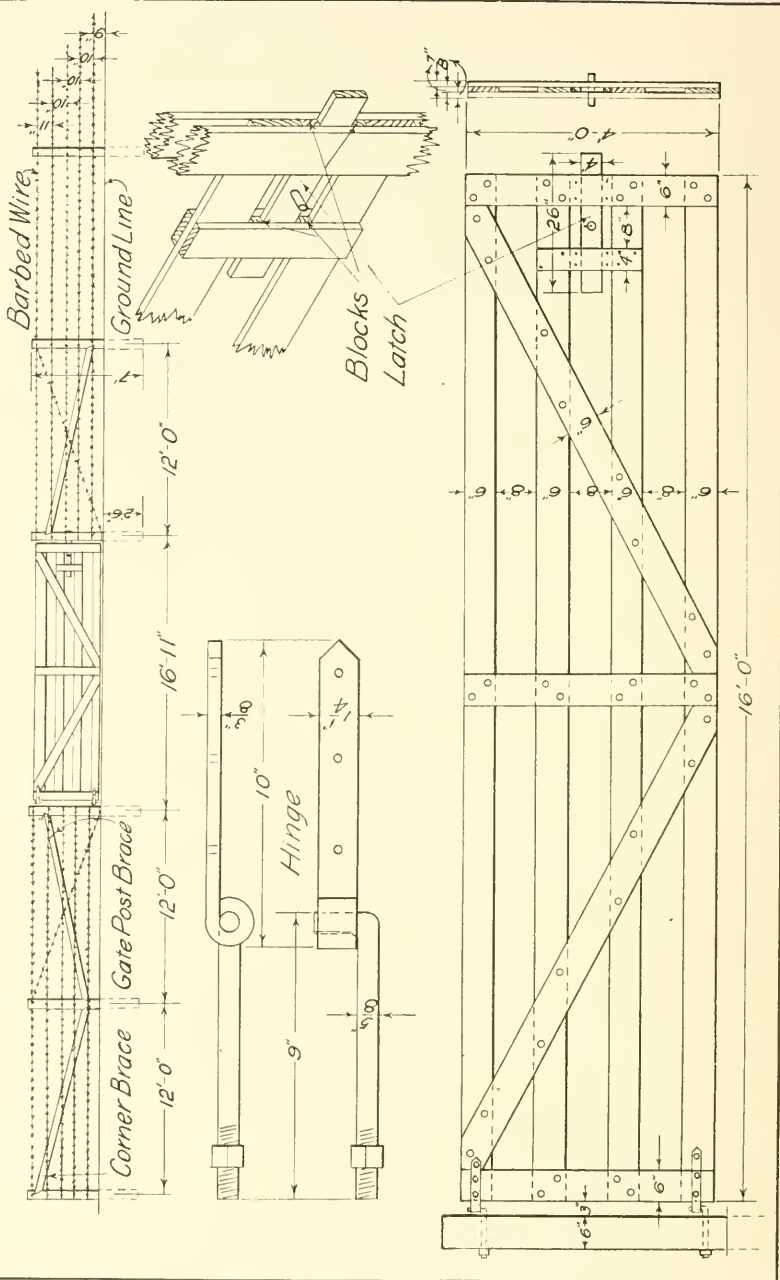
SINGLETREE

Lumber: 1 piece of hickory or ash $2\frac{1}{4}'' \times 2\frac{3}{4}'' \times 2' 10''$.

Directions

1. Square up the stock to finished dimensions.
2. Find the center at each end by drawing lines diagonally as shown in the detail drawing.
3. Draw a circle at center of each end $1\frac{1}{2}''$ in diameter.
4. Cut a templet of pasteboard as shown in the detail drawing and use in getting the singletree a perfect oval at the center.
5. In removing the stock, bring it to a square at the end, then an octagon and then a circle. Remove the bulk of the stock with the saw and finish with the plane. The singletree may be sanded to produce a smooth finish.

Fence and Gate



FENCE AND GATE

Material Required

Lumber: 5 pieces white or yellow pine $\frac{7}{8}$ "x6"x16' 0".

2 pieces white or yellow pine $\frac{7}{8}$ "x6"x14' 0".

1 piece white or yellow pine $\frac{7}{8}$ "x4"x6' 0".

1 piece round hardwood $\frac{5}{8}$ "x6".

(Oregon pine or cypress may be substituted for white or yellow pine.)

Hardware: 2 pair screw hook and strap hinges.

26 carriage bolts $\frac{3}{8}$ "x3".

16 carriage bolts $\frac{3}{8}$ "x2".

23 6d common nails.

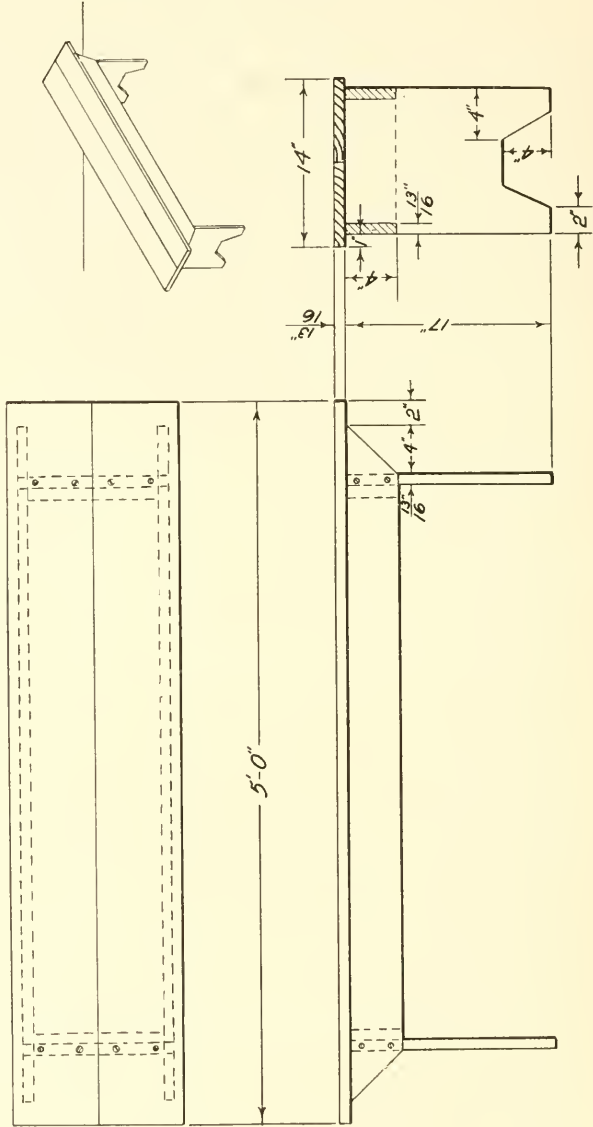
Stock Bill

Pieces.	Finished Dimensions.	Use..
4.	$\frac{7}{8}$ "x6"x16' 0"	Horizontal pieces.
6.	$\frac{7}{8}$ "x6"x4' 0"	Vertical pieces.
2.	$\frac{7}{8}$ "x6"x8' 3"	Braces.
2.	$\frac{7}{8}$ "x4"x20"	Uprights for latch
1.	$\frac{3}{4}$ "x4"x2' 2"	Latch.
2.	$\frac{7}{8}$ "x2"x4".	Blocks above and below latch.
2.	$\frac{7}{8}$ "x2"x6"	Blocks above and below latch.
1.	$\frac{5}{8}$ " round x 6" long	Knob.

Directions

1. Reduce all pieces to finished dimensions.
2. Fasten the vertical pieces to the horizontal pieces by placing two $\frac{3}{8}$ "x3" carriage bolts at each joint.
3. Fasten the braces to the horizontal members by using two $\frac{3}{8}$ "x2" carriage bolts at places indicated in the drawing.
4. Bore a $\frac{5}{8}$ " hole in the center of the latch for the knob; place knob in position and fasten by driving a 6d nail into the upper edge of the latch so that the point of the nail will go into the knob.
5. Place latch in position.
6. Assemble the uprights for the latch to the two middle horizontal pieces 8" from the front end vertical piece by driving two 6d common nails at each end from each side.
7. In like manner fasten the blocks above and below the latch, as shown in the detail drawing, using two 6d nails from each side.

Bench



BENCH.

Material Required.

Lumber—1 piece white pine 13/16''x12''x3' 0''
 1 piece white pine 13/16''x4''x12' 0''
 1 piece white pine 13/16''x7''x10' 0''

Hardware—12 flat head bright wood screws 1¼'' No. 8
 16 flat head bright wood screws 1¾'' No. 10

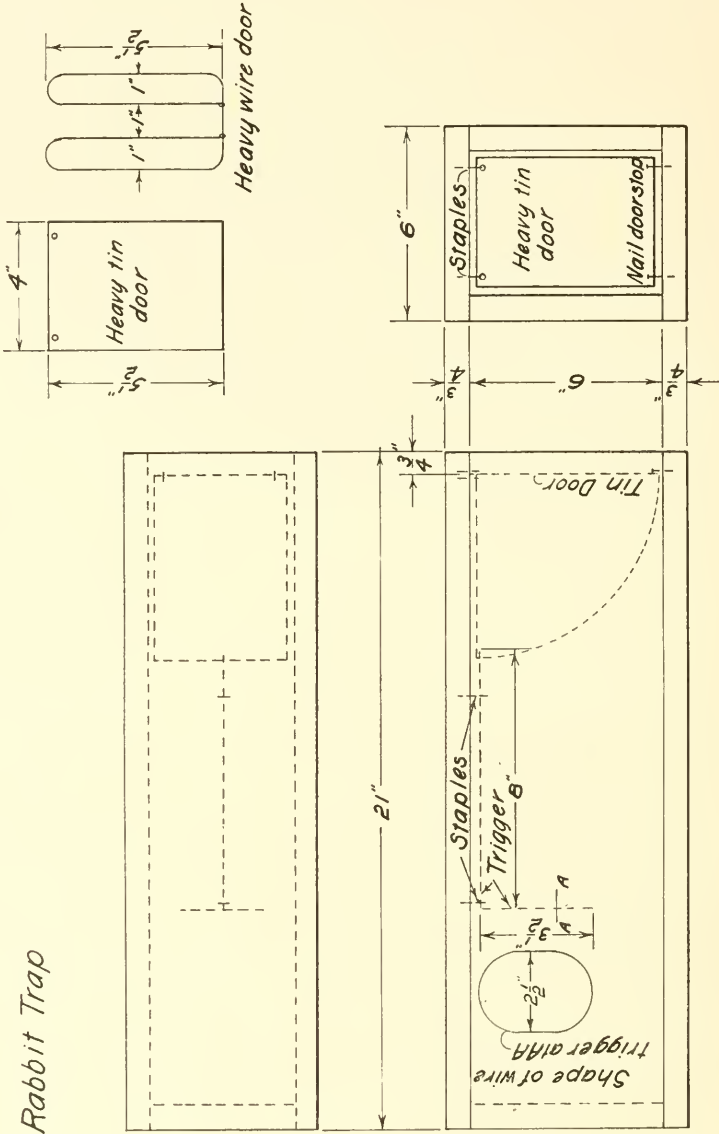
Stock Bill.

Pieces	Finished Dimensions	Use
2	13/16''x12''x17''	Legs
2	13/16''x4''x10¾''	Cross braces
2	13/16''x4''x4' 8''	Aprons
2	13/16''x7''x5' 0''	Top

Directions.

1. Reduce all pieces to finished dimensions.
2. Lay out the opening at the lower end of the legs and remove the stock with the rip saw and coping saw.
3. Cut the openings for the aprons on each edge at the upper end of the legs.
4. Bore holes with No. 5 wood twist drill and fasten the cross braces with five flat head bright wood screws 1¼'' No. 8.
5. Bore holes with 3/16'' wood twist drill; countersink the holes and fasten the aprons with two flat head bright wood screws 1¾'' No. 10.
6. Bore holes in the top with 3/16'' wood twist drill, countersink the holes and fasten top with 1¾'' No. 10 flat head bright wood screws.

Rabbit Trap



RABBIT TRAP.

Material Required.

Lumber—One piece of any kind of wood (preferably old weathered),
1''x6''x8' 0''

Hardware—2 doz. 8d common nails

4 staples (poultry netting)

1 piece of heavy wire 18'' long for trigger

1 piece of heavy tin or galvanized iron 4''x5½'' for door

2 3d shingle nails

Stock Bill.

Pieces	Dimensions	Use
4	1''x6''x21''	Sides, top and bottom
1	1''x4''x6''	End

Directions.

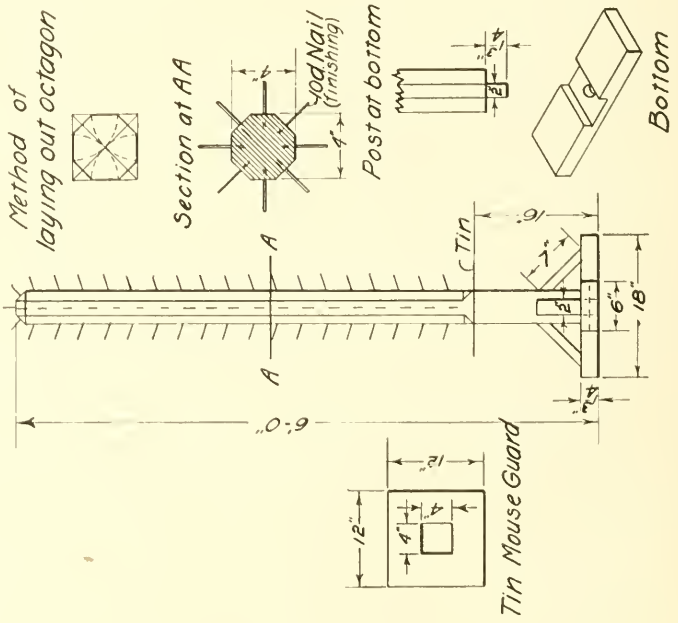
As little planing as possible should be done so as to retain the weathered surface of the wood.

1. Reduce all pieces to finished dimensions.
2. Bend the wire for the trigger as indicated in the drawing.
3. Nail the staples for holding the trigger to the bottom side of the top.
4. Nail the top and bottom to the sides, using four nails for each joint.
5. Place the trigger in position through the staples.
6. Nail the end in place using two nails for each joint.
7. Punch or drill holes $\frac{1}{4}$ '' from the upper edge and $\frac{1}{2}$ '' from each side of the tin door and fasten door in position with staples.
8. Place the two 3d nails at places shown in the drawing for door stops

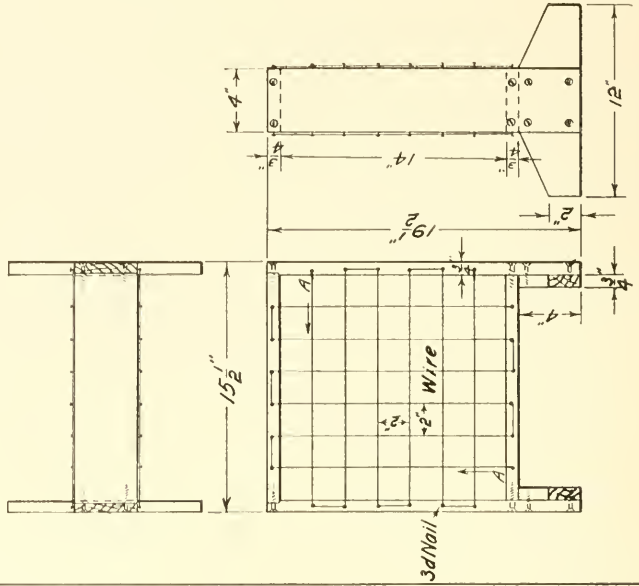
A heavy wire door made as shown in the detail drawing may be used instead of the tin door.

Old weathered lumber is preferable to new as it more closely resembles a hollow log.

Seed Corn Tree



Seed Corn Curing Frame



SEED CORN CURING FRAME

Material Required.

Lumber—1 piece 1"x4"x8' 0" any soft wood

Hardware—8 flat head bright wood screws 1 $\frac{1}{4}$ " No. 7

8 flat head bright wood screws 1 $\frac{3}{4}$ " No. 10

30 ft. of No. 18 annealed wire

48 3d fine shingle nails

Stock Bill.

Pieces	Finished Dimensions	Use
2	$\frac{3}{4}$ "x4"x12"	Feet
2	$\frac{3}{4}$ "x4"x19 $\frac{1}{2}$ "	Uprights
1	$\frac{3}{4}$ "x4"x14"	Lower cross piece
1	$\frac{3}{4}$ "x4"x14 $\frac{1}{2}$ "	Upper cross piece

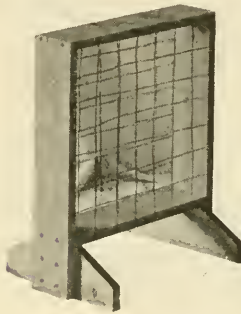


Fig. 28. Seed Corn Curing Frame

Directions.

This frame may be made larger to suit larger quantities of corn by merely adding to the length of uprights, cross pieces and wire.

1. Reduce all pieces to finished dimensions.

2. To lay out feet draw a line across both ends of stock 2" from the lower edge and two lines across top edge 4" from either end. Connect lines on end with those on edge with straight lines and remove stock with saw and plane.

3. Cut a gain $\frac{1}{8}$ " deep x $\frac{3}{4}$ " wide on one side of each upright at the upper end for upper cross piece.

4. Fasten uprights to feet by placing four 1 $\frac{1}{4}$ " No. 7 screws as shown in end view.

5. Fasten cross pieces by placing two 1 $\frac{3}{4}$ " No. 10 screws in each end of each piece.

6. Place the 3d fine shingle nails 2" apart as shown in drawing.

7. Use the pliers in drawing the wire taut, beginning at A and drawing in direction of arrow points.

SEED CORN TREE

Material Required.

Lumber—1 piece 4''x4''x6' 0'' of any kind of soft wood
 1 piece 2''x6''x3' 0'' of any kind of soft wood
 1 piece 1''x2''x2' 6'' of any kind of soft wood

Hardware—16 flat head bright wood screws 1 $\frac{1}{4}$ '' No. 8
 1 $\frac{1}{4}$ lb. 10d finishing nails
 1 piece tin 12''x12''

Stock Bill.

Pieces	Finished Dimensions	Use
1	4''x4''x6' 0''	Tree
2	1 $\frac{3}{4}$ ''x6''x18''	Foot
4	13/16''x2''x7''	Braces

Directions.

1. Reduce all pieces to finished dimensions.
2. Lay out an octagon on the upper end of the tree as shown in the detail drawing and then lay out a chamfer on each corner of the tree to within 16'' of the lower end of the tree. Remove stock for chamfer with plane and chisel.
3. Shape top of tree as shown in drawing, removing the stock with the plane.
4. Lay out a half lap joint for the two pieces for the foot; remove the stock with saw and chisel.
5. With saw and chisel, shape the lower end of post as shown in detail of "post at bottom."
6. Place the two pieces for the foot together and bore a 2'' hole through the center for bottom of post.
7. Brace the post as shown in the drawing, using two screws at each end of each piece.
8. Cut a square hole in the center of the tin mouse guard as large as the tree and strip on the tree to bottom of chamfer.
9. Place nails 3'' apart in a staggered position at about such slant as shown in drawing.

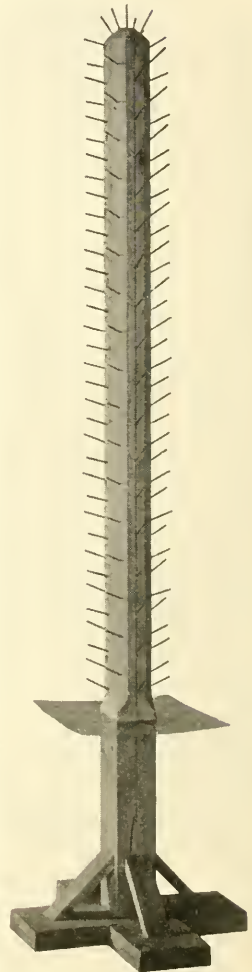


Fig. 29. Seed Corn Tree

CHICKEN BROODER, COOP AND RUN

Material Required

- Lumber—1 piece soft pine, cypress, fir or basswood 1''x1''x12' 0''
 2 pieces soft pine, cypress, fir or basswood 1''x10''x12' 0''
- Hardware— $\frac{1}{4}$ lb. 6d common nails
 $\frac{1}{4}$ lb 8d common nails
 30 8d finishing nails
 16 3d fine shingle nails
 16 flat head bright wood screws $1\frac{1}{2}$ '' No. 9
 27 flat head bright wood screws $\frac{3}{4}$ '' No. 6
 1 piece of fine screen 6''x11''
 1 piece of fine screen $10\frac{1}{2}$ ''x12''
 1 piece of 1'' mesh chicken wire 13''x3' 9''
 1 piece of 1'' mesh chicken wire 13''x5' 0''
 1 piece of 2'' mesh chicken wire 27''x5' 0''
 2 gate hooks and eyes
 1 piece heavy tin 11''x14 $\frac{1}{2}$ ''
 1 piece heavy tin or galvanized iron 11''x16 $\frac{1}{4}$ ''
 1 piece heavy wire 16''
 $\frac{1}{4}$ lb. $\frac{3}{4}$ '' galvanized poultry netting staples

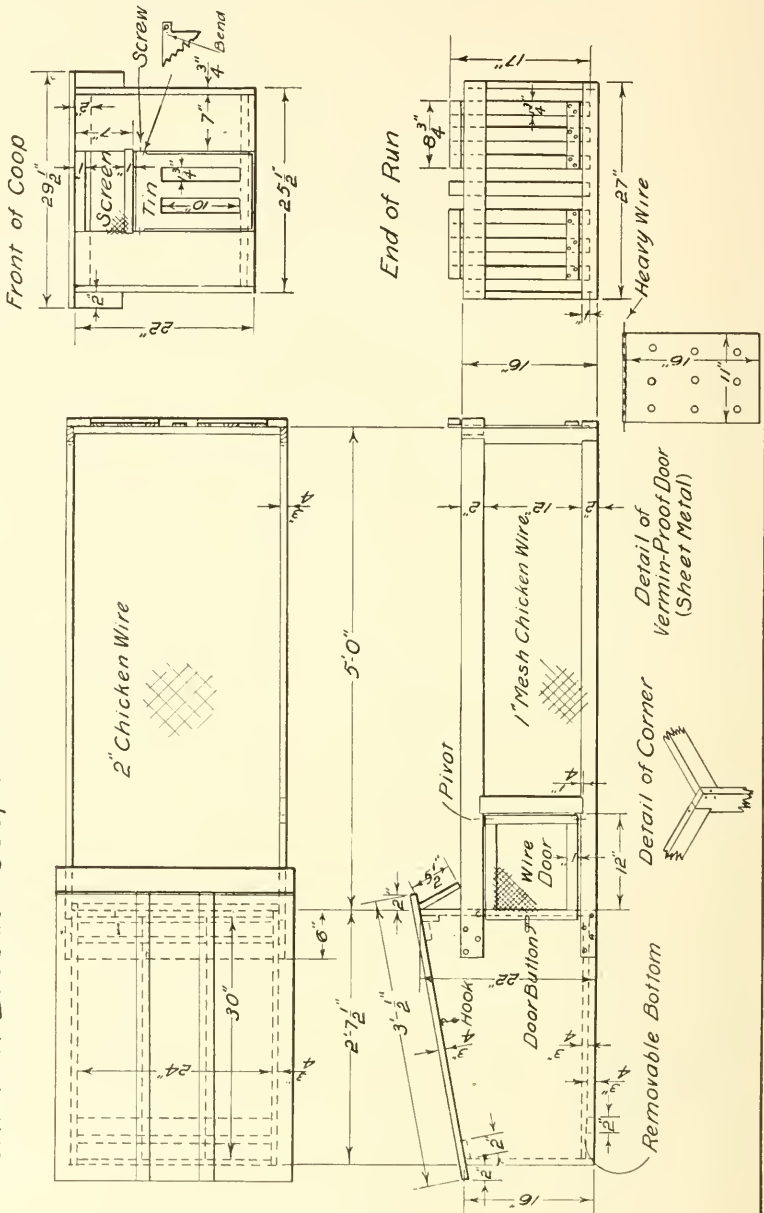
Stock Bill

Pieces	Finished Dimensions	Use
3	$\frac{3}{4}$ ''x8''x30''	Bottom
2	$\frac{3}{4}$ ''x2''x24''	Bottom cleats
4	$\frac{3}{4}$ ''x11''x2' 7 $\frac{1}{2}$ ''	Side of coop
2	$\frac{3}{4}$ ''x8''x24''	Rear end of coop
2	$\frac{3}{4}$ ''x7''x22''	Front end of coop
1	$\frac{3}{4}$ ''x2''x24''	Cleat inside of front at top
2	$\frac{3}{4}$ ''x1''x10''	Front of coop
2	$\frac{3}{4}$ ''x10''x3' $\frac{1}{2}$ ''	Top of coop
1	$\frac{3}{4}$ ''x9 $\frac{1}{2}$ ''x3' $\frac{1}{2}$ ''	Top of coop
2	$\frac{3}{4}$ ''x2''x24''	Cleats for top
2	$\frac{3}{8}$ ''x1 $\frac{1}{2}$ ''x3' $\frac{1}{2}$ ''	Battens for top
1	$\frac{3}{4}$ ''x5 $\frac{1}{2}$ ''x20''	Rain shield at front
4	$\frac{3}{4}$ ''x2''x5' 6''	Sides of run
2	$\frac{3}{4}$ ''x2''x16''	Corner posts of run
2	$\frac{3}{4}$ ''x2''x25 $\frac{1}{2}$ ''	End of run
1	$\frac{3}{4}$ ''x2''x12 $\frac{1}{2}$ ''	Cross brace inside of run
2	$\frac{3}{4}$ ''x1''x11''	Top and bottom of side door
2	$\frac{3}{4}$ ''x1''x11 $\frac{1}{2}$ ''	Ends of side door
2	$\frac{3}{4}$ ''x2''x27''	Straps for door at end of run
4	$\frac{3}{8}$ ''x1 $\frac{3}{4}$ ''x8 $\frac{3}{4}$ ''	Straps at end of gates
7	$\frac{3}{8}$ ''x1 $\frac{3}{4}$ ''x17''	Uprights for doors
1	$\frac{3}{8}$ ''x $\frac{3}{4}$ ''x2''	Door button

Directions

1. Reduce all pieces to finished dimensions and label each piece.
2. Fasten the bottom cleats to the bottom by driving three 6d common nails at each joint. The nails should be driven at a slant so as not to come through.
3. Assemble top in same way as bottom.

Chicken Brooder Coop and Run

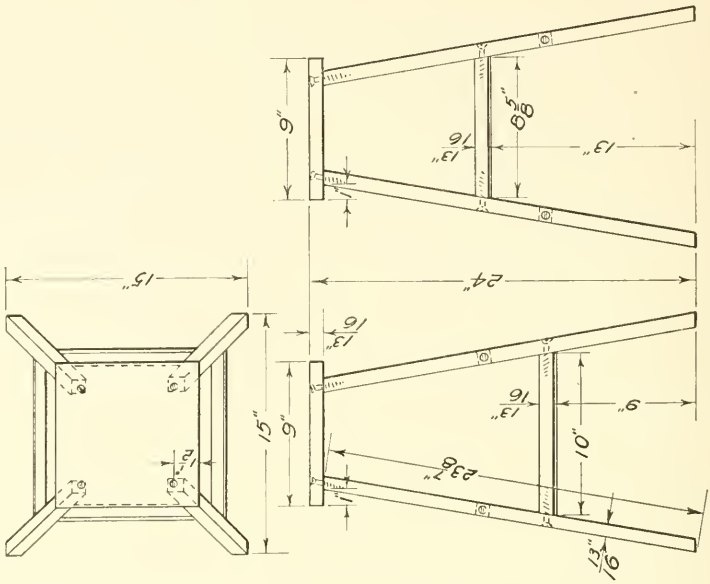


4. Nail the battens over the joints on top of the coop with 3d fine shingle nails.
5. Nail the sides to the ends of the box by using four 8d common nails at each side of the back end and five 8d common nails at each side of the front end.
6. Fasten the two main front pieces by nailing to them the $\frac{3}{4}$ "x2"x24" cleat on the inside at the top. Cut gains 1" wide and $\frac{1}{4}$ " deep, 6" from the top on the inside edges of the main front pieces.
7. Fasten the two pieces in position indicated in the drawing by toenailing them to the two main front pieces and fasten the 6"x11" fine screen with poultry netting staples.
8. Assemble the side door by using two 8d finishing nails to hold the butt joint at each corner.
9. Fasten the 10 $\frac{1}{2}$ "x12" piece of fine screen to the side door with poultry netting staples.
10. Cut the head from an 8d finishing nail and cut it into two equal pieces for pivots for the side door. Drill holes for the pivots in the door and sides of run as indicated in the drawing and place pivots in the door.
11. Cut gains $\frac{1}{4}$ " deep in one edge of two pieces for sides of run 18" from one end for cross brace and fasten in place with two 8d finishing nails at each end.
12. Cut gains at both ends of corner posts $\frac{1}{2}$ " deep x 2" wide as shown in detail of corner and fasten corners of coop by placing four 8d finishing nails as shown in detail.
13. Fasten run to coop by driving four 1 $\frac{1}{2}$ " No. 9 flat head bright wood screws through each side of run into the coop.
14. Bore hole through the center of the door button and fasten in place with one $\frac{3}{4}$ " No. 6 screw.
15. Cut the 11"x14 $\frac{1}{2}$ " piece of heavy tin to the pattern shown in front of coop, drill a hole for screw in each flange, bend flange and place door in position with two $\frac{3}{4}$ " No. 6 screws.
16. Bore $\frac{1}{2}$ " holes in 11"x16 $\frac{1}{2}$ " piece of sheet metal for ventilation, fold one end over the heavy wire as shown in detail drawing and fasten over front of main door with one staple at each end.
17. Fasten the straps to the pieces for the end gates by using two $\frac{3}{4}$ " No. 6 screws at each joint.
18. Cut grooves $\frac{3}{8}$ " deep and 1 $\frac{3}{4}$ " wide in the straps for doors at end of run to receive the end gates.
19. Place gates in position and nail straps to end of run with two nails at each joint.
20. Fasten the chicken wire to sides and top of coop.
21. Fasten the rain shield in position shown in drawing by driving two 6d common nails into each main piece at front of coop.
22. Paint the coop and run if desired.

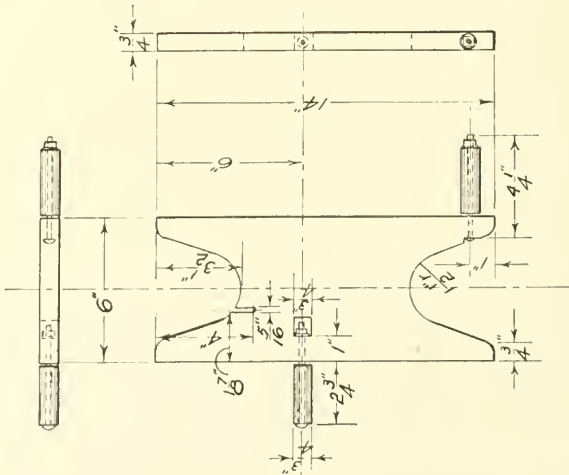


Fig. 30. Chicken Brooder, Coop and Run.

Kitchen Stool



Clothes Line Reel



KITCHEN STOOL

Material Required.

- Lumber—1 piece of oak, maple, basswood or white pine 1''x9''x9''
 1 piece of oak, maple, basswood or white pine 1''x6 $\frac{1}{2}$ ''x24''
 Hardware—12 flat head bright wood screws 2 $\frac{1}{4}$ '' No. 12

Stock Bill.

Pieces	Finished Dimensions	Use
1	13/16''x9''x9''	Top
4	13/16''x13/16''x23 $\frac{7}{8}$ ''	Legs
2	13/16''x13/16''x10''	Braces
2	13/16''x13/16''x8 $\frac{3}{8}$ ''	Braces

Directions.

1. Reduce stock to finished dimensions.
2. Lay out and cut a $\frac{1}{8}$ '' chamfer on upper edges of top.
3. Set the T-bevel by using the figures 12 and 2 $\frac{1}{4}$ on the steel square and lay out and cut the beveled ends of both legs and braces.
4. Find the centers of ends of braces and upper ends of legs by drawing lines diagonally across the ends and bore a hole about $\frac{3}{4}$ '' deep with No. 5/32 twist drill.
5. Locate points on top board at each corner 1 $\frac{1}{2}$ '' from each edge.
6. At points just located bore holes with No. 7 twist drill. Use the T-bevel as set for the bevel cuts of legs to guide the bit at the same angle that the legs are to assume.
7. Bore holes with No. 7 twist drill for all braces; two braces to be placed 9'' and two 13'' from the bottom of the stool.
8. Countersink all screw holes and place screws.
9. The stool may be finished with two coats of shellac or interior paint.

CLOTHES LINE REEL

Material Required.

- Lumber—1 piece basswood, white pine, gumwood, redwood, oak or maple 1''x6''x14''
 Hardware—2 carriage bolts $\frac{1}{4}$ ''x4 $\frac{1}{4}$ '' with three washers each.

Stock Bill.

Pieces	Finished Dimensions	Use
1	$\frac{3}{4}$ ''x6''x14''	Reel
2	$\frac{3}{4}$ '' round x 2 $\frac{3}{4}$ '' long	Handles

Directions.

1. Reduce reel to finished dimensions.
2. Draw a centerline lengthwise of stock on both sides.
3. On centerline at each end of stock swing an arc with a 1 $\frac{1}{2}$ '' radius so that edge of arc is 3 $\frac{1}{2}$ '' from end of stock.
4. Draw lines across ends $\frac{3}{4}$ '' from edge and from these points draw lines tangent to the arcs.
5. Remove the stock at ends with rip saw and turning saw or coping saw.
6. Round the corners as shown in the drawing with the chisel.
7. From the stock taken from ends square up two pieces $\frac{3}{4}$ ''x $\frac{3}{4}$ ''x2 $\frac{3}{4}$ '' for handle.
8. Bore a $\frac{1}{4}$ '' hole through center of both pieces lengthwise.
9. Round the handle by laying out an octagon at each end, cutting the stock octagonal in shape with the plane and then removing the edges until stock is round.
10. On a line drawn across the stock 6'' from one end lay out a $\frac{3}{4}$ '' square 1'' from one edge and remove the stock with a $\frac{3}{4}$ '' bit and chisel.
11. Bore a $\frac{1}{4}$ '' hole in edge of stock to meet the center of the square hole.
12. Bore a $\frac{1}{4}$ '' hole in opposite edge 1'' from the 8'' end.
13. Place handles in position, using one washer at the head of the bolt, one between handle and reel and one next to the nut.
14. Mar the thread on the bolt slightly to prevent the nut from coming off.
15. Bore a 5/16'' hole through the reel 1 $\frac{1}{8}$ '' from one edge and 4'' from one end and cut an opening to hold the end of the clothesline.

STEP LADDER

Material Required.

- Lumber—1 piece of white or Norway pine 1"x8"x10' 0"
 Hardware—18 flat head bright wood screws 2" No. 10
 4 flat head bright wood screws 2½" No. 10
 4 round head blued wood screws ¾" No. 6
 2, 2"x2" steel box hinges
 1 piece leather or canvas strap 21" long

Stock Bill.

Pieces	Finished Dimensions	Use
2	¾"x3½"x2' 9"	Front Standards
2	¾"x2"x2' 6¼"	Back Standards
3	¾"x4¾"x14¾"	Steps
1	¾"x5½"x18"	Top
1	¾"x2"x16"	Top Brace
1	¾"x2"x13"	Bottom Brace

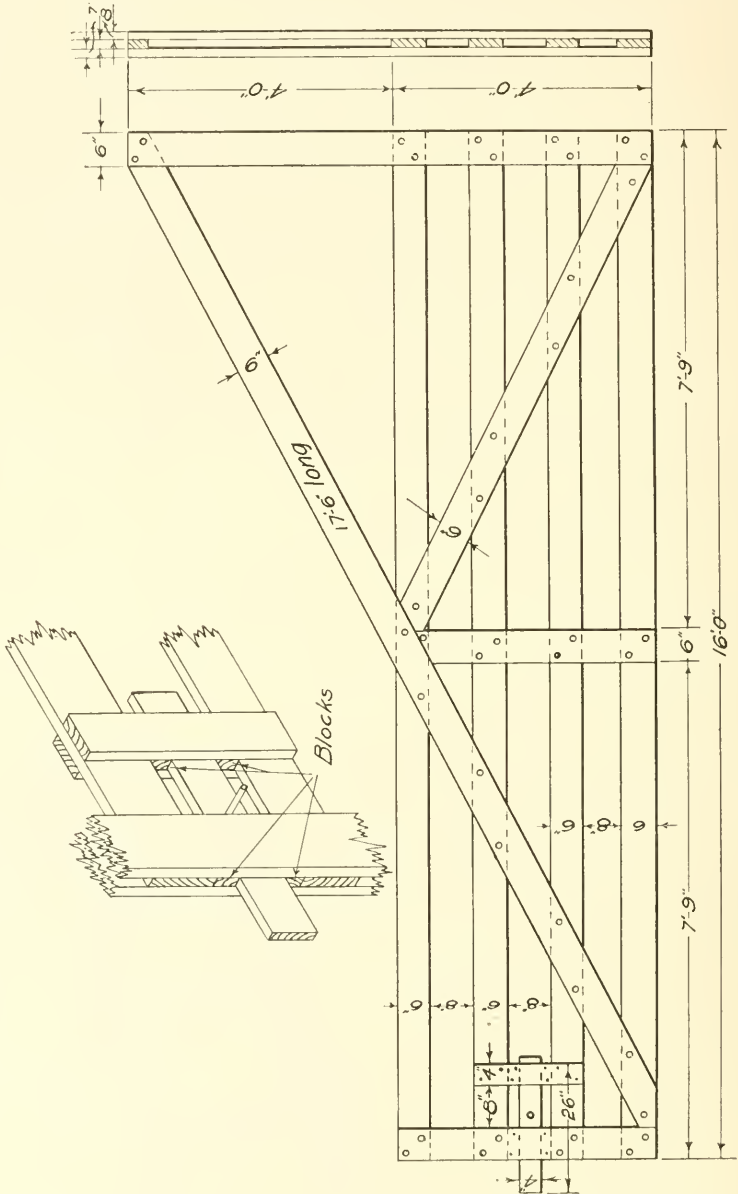
Directions.

1. Reduce all pieces to finished dimensions.
2. Set the T-bevel at an angle obtained by using 14⁵/₈" on the beam and 6" on the blade of the steel square and lay out the bevel cuts at both ends of the front standards and remove stock to line. —
3. With T-bevel set as for the standards lay out the cuts for the steps. Saw grooves ⅝" deep for the steps and remove stock with chisel.
4. Bevel the upper edge of the top brace with the T-bevel set as for the steps.
5. With the T-bevel set at an angle obtained by using 13½" on the beam and 6" on the blade of the steel square, bevel the lower ends of the back standards.
6. Lay out the gain for the bottom brace on the inside edges of the back standards ½" deep and 2" wide, 5" from the lower ends of the standards and fasten brace in place using two 2½" screws at each end.
7. Bevel both edges of the steps at the same bevel as used for the ends of the front standards.
8. Fasten the steps by placing two 2" No. 10 flat head screws in each end of each step.
9. Fasten the top to the front standards, placing two 2" No. 10 flat head screws through the top into each standard. Place screws as shown in drawing. Fasten the top brace to the top and front standards by driving two 2" No. 10 flat head bright wood screws through the top brace at each end into the standard.
11. Fasten the back standards by placing the hinges as indicated in the drawing.
12. Fasten the leather or canvas strap to the lower side of the bottom step and the upper edge of the bottom brace by using two ¾" No. 6 round head blued wood screws at each end.
13. Paint the ladder if desired.



Fig. 31. Ladder.

Swinging Farm Gate



SWINGING FARM GATE

Material Required.

Lumber—1 piece white or yellow pine, fir or cypress 1''x6''x18' 0''
 5 pieces white or yellow pine, fir or cypress 1''x6''x16' 0''
 2 pieces white or yellow pine, fir or cypress 1''x6''x12' 0''
 1 piece white or yellow pine, fir or cypress 1''x4''x7' 4''
 1 piece hardwood $\frac{3}{4}$ '' round x 6'' long

Hardware—25 carriage bolts $\frac{3}{8}$ ''x3''
 4 carriage bolts $\frac{3}{8}$ ''x2 $\frac{1}{4}$ ''
 2 pair screw hook and strap hinges
 25 6d nails

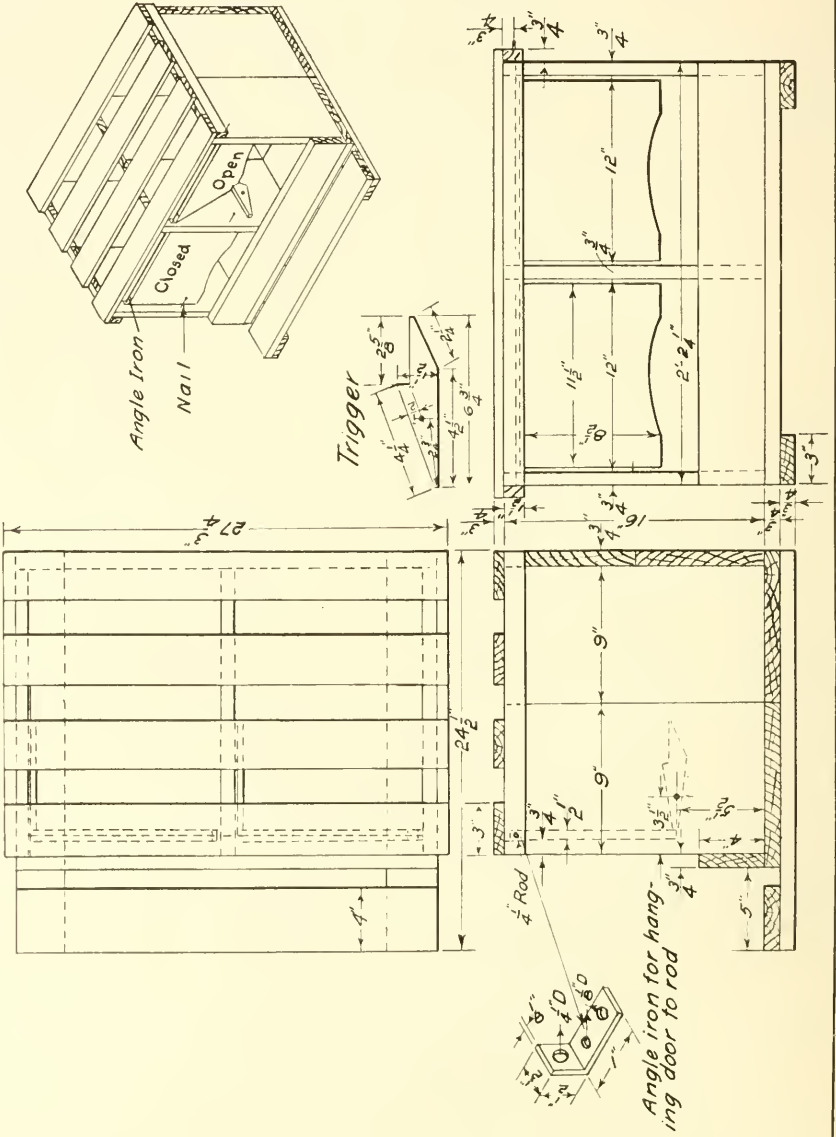
Stock Bill.

Pieces	Finished Dimensions	Use
1	$\frac{7}{8}$ ''x6''x17' 6''	Long arm
4	$\frac{7}{8}$ ''x6''x16' 0''	Horizontal pieces
2	$\frac{7}{8}$ ''x6''x8' 0''	End uprights
2	$\frac{7}{8}$ ''x6''x4' 0''	End uprights
1	$\frac{7}{8}$ ''x6''x4' 0''	Middle upright
1	$\frac{7}{8}$ ''x6''x3' 9''	Middle upright
1	$\frac{7}{8}$ ''x6''x8' 1 $\frac{1}{2}$ ''	Brace
1	$\frac{3}{4}$ ''x4''x26''	Latch
2	$\frac{7}{8}$ ''x4''x20''	Uprights for latch
2	$\frac{7}{8}$ ''x1 15/16''x4''	Blocks above and below latch
2	$\frac{7}{8}$ ''x1 15/16''x6''	Blocks above and below latch
1	$\frac{3}{4}$ '' round x 6'' long	Knob

Directions.

1. Reduce all pieces to finished dimensions.
2. Fasten the vertical pieces to the horizontal pieces by placing two $\frac{3}{8}$ ''x3'' carriage bolts at each joint.
3. Fasten the long arm and the braces to the horizontal by placing the $\frac{3}{8}$ ''x2 $\frac{1}{4}$ '' carriage bolts as indicated in the drawing.
4. Bore a $\frac{3}{4}$ '' hole through the center of the latch for the knob; place knob in position and fasten by driving a 6d nail into the upper edge of the latch so that the point of the nail will go into the latch.
5. Place latch in position and fasten the uprights for the latch to the two middle horizontal pieces 8'' from the front end vertical piece by driving two 6d common nails at each end from each side.
6. In like manner fasten the blocks above and below the latch, as indicated in the detail drawing using two 6d nails from each side.

Trap Nest



TRAP NEST

Material Required.

Lumber—2 pieces white pine, cypress, fir or redwood 1''x10''x14' 0''
 1 piece white pine, cypress, fir or redwood $\frac{3}{8}$ ''x11''x24''

Hardware—1 piece iron $\frac{1}{8}$ ''x $\frac{1}{2}$ ''x6''
 1 iron rod $\frac{1}{4}$ ''x30''
 $\frac{1}{4}$ lb. 6d common nails
 $\frac{1}{2}$ lb. 8d common nails
 4 round head blued wood screws $\frac{3}{4}$ '' No. 7 for angle irons
 2 round head blued wood screws 1 $\frac{1}{4}$ '' No. 10 for triggers

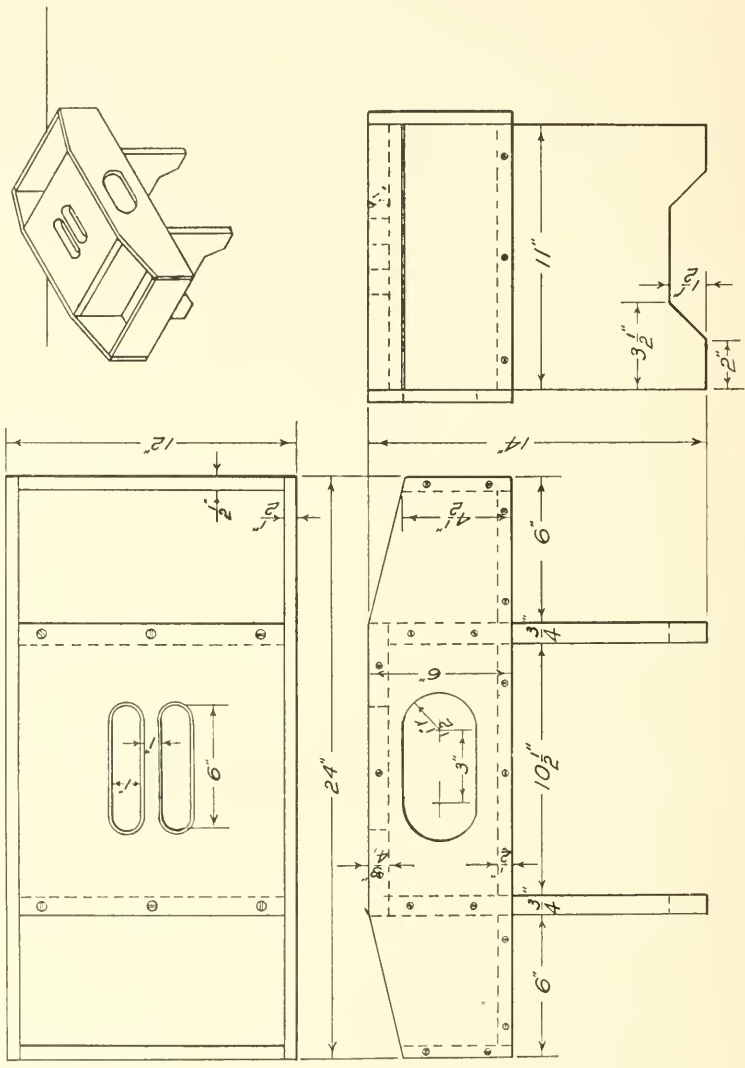
Stock Bill.

Pieces	Finished Dimensions	Use
2	$\frac{3}{4}$ ''x3''x24 $\frac{1}{2}$ ''	Sills
2	$\frac{3}{4}$ ''x9 $\frac{3}{4}$ ''x26 $\frac{1}{4}$ ''	Floor
1	$\frac{3}{4}$ ''x4''x26 $\frac{1}{4}$ ''	Step
1	$\frac{3}{4}$ ''x4''x26 $\frac{1}{4}$ ''	Front
6	$\frac{3}{4}$ ''x9''x16''	Ends and Partition
2	$\frac{3}{4}$ ''x8''x26 $\frac{1}{4}$ ''	Back
2	$\frac{3}{4}$ ''x1 $\frac{1}{2}$ ''x18 $\frac{3}{4}$ ''	Side straps
1	$\frac{3}{4}$ ''x1 $\frac{1}{2}$ ''x26 $\frac{1}{4}$ ''	Front at top
4	$\frac{3}{4}$ ''x3''x27 $\frac{3}{4}$ ''	Top
2	$\frac{3}{8}$ ''x8 $\frac{1}{2}$ ''x11 $\frac{1}{2}$ ''	Doors
2	$\frac{3}{8}$ ''x1 $\frac{1}{2}$ ''x6 $\frac{3}{4}$ ''	Triggers

Directions.

1. Reduce all pieces to finished dimensions.
2. Fasten the ends and partition to the floor by driving three 8d common nails through the floor into each board.
3. Nail the front in place using two 6d common nails at each joint.
4. Fasten the sills to the bottom with four 8d nails for each sill. The nails should be driven through the floor and into the ends.
5. Use two 6d nails to fasten the step. The nails may be placed at a slant so as not to come through and require clinching.
6. Nail the back boards in the same manner as the floor.
7. Nail the top boards in place using two 8d nails at each joint.
8. Fasten the side straps by driving one 6d nail through each top board at the end and two 6d nails into each end board. Place nails which go into the end boards at a slant.
9. Locate points on end boards and partition $\frac{3}{4}$ '' from top and 1'' from front and bore $\frac{1}{4}$ '' hole for rod.
10. Drill holes in angle iron and bend as shown in detail drawing and fasten to top of doors with two round head blued wood screws $\frac{3}{4}$ '' No. 7.
11. Make triggers to dimensions shown in detail drawing and place in position shown in side view using 1 $\frac{1}{4}$ '' No. 10 round head blued wood screws.
12. Place nails to prevent door from swinging forward.

Hive Seat and Tool Box



HIVE SEAT AND TOOL BOX

Material Required.

- Lumber—1 piece white pine 13/16"x12"x3' 4"
 1 piece white pine 1/2"x11"x22"
 1 piece white pine 1/2"x6"x6' 0"
- Hardware— 6 flat head bright wood screws 1 3/4" No. 10
 34 flat head bright wood screws 1" No. 8
 12 6d finishing nails

Stock Bill.

Pieces	Finished Dimensions	Use
2	3/4"x11"x13 1/4"	Legs
1	3/4"x11"x12"	Top
1	1/2"x11"x10 1/2"	Bottom
2	1/2"x6"x24"	Sides
2	1/2"x4 1/2"x11"	Ends
2	1/2"x5 1/2"x11"	Bottom

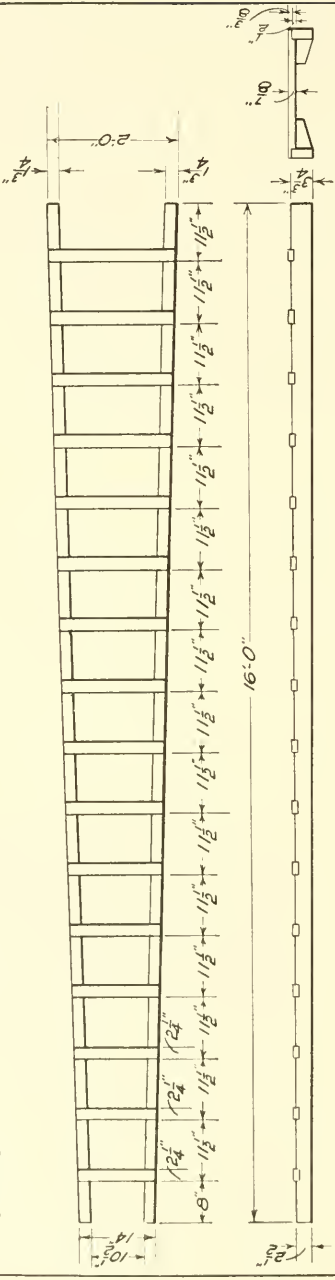
Directions.

1. Reduce all pieces to finished dimensions.
2. Lay out the opening at the lower end of the legs and remove the stock with rip saw and coping saw.
3. To lay out the opening in the side draw a center line lengthwise and crosswise of the stock, locate points on long centerline 1 1/2" from center and swing arcs with 1 1/2" radius. Draw lines tangent to the arcs. Bore a hole with a bit inside of the circle so that the outside of the hole touches the circle; place a coping saw in the hole and remove the stock.
4. Lay out the upper edge at the ends of the side pieces as shown in the drawing and remove the stock with the plane.
5. To lay out the hand opening in the top draw two parallel lines lengthwise of the stock one inch on either side of the center. Draw a centerline across the stock and locate points on parallel lines 2 1/2" from the center.
6. Bore 1" holes at points just located and also remove the stock between holes with 1" bit.
7. Finish cutting the opening with 3/4" chisel.
8. Lay out a 1/8" chamfer on both sides of the stock at the edge of the openings.
9. Cut chamfers with chisel.
10. Assemble the parts in the following order: top to legs, sides to legs, bottom at center, ends, bottom at ends.
11. Place screws as indicated in the drawing using 1 3/4" flat head bright wood screws at the top and 1" No. 8 screws at the other places.
12. Fasten the bottom of the center by driving three 6d finishing nails thru the leg and into the end of the bottom piece.
13. Fasten the inside end of the bottom at end by toenailing.

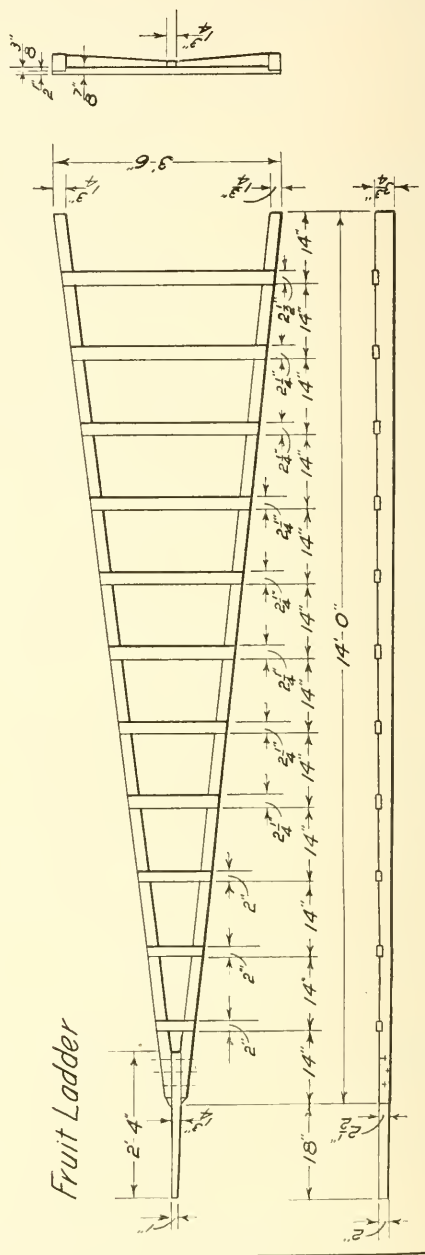


Fig. 32. Hive Seat and Tool Box in Use.

Ladder



Fruit Ladder



LADDER

Material Required.

- Lumber—2 pieces ash or yellow pine 2"x4"x16' 0"
 2 pieces ash or yellow pine $\frac{7}{8}$ "x2 $\frac{1}{4}$ "x14' 0"
 Hardware—64 flat head bright wood screws 2" No. 12

Stock Bill.

Pieces	Finished Dimensions	Use
2	1 $\frac{3}{4}$ "x3 $\frac{3}{4}$ " at foot and 2 $\frac{1}{2}$ " at top x 16' 0"	Stringers
16	$\frac{7}{8}$ "x2 $\frac{1}{4}$ " x length of various rungs	Rungs

Directions.

1. Taper the stringers to 2 $\frac{1}{2}$ " at the upper ends, using one stringer as a straight edge for laying out the taper on the other.
2. Place stringers on the floor or bench in the position which they are to assume when assembled, place lower rung in position and set the T-bevel for laying out the gains for the rungs.
3. Lay out and cut gains $\frac{3}{8}$ " deep and as wide as the rungs 11 $\frac{1}{2}$ " apart. Several saw kerfs at each joint makes it easier to remove the stock than if only two were used, one at each edge of the gain.
4. Cut rungs to length.
5. Bore and countersink holes for two 2" No. 12 screws at each joint and fasten rungs in place. The holes should be countersunk deep enough so that the heads of the screws will be slightly below the surface of the wood.

FRUIT LADDER

Material Required.

- Lumber—2 pieces ash or yellow pine 2"x4"x14' 0"
 1 piece ash or yellow pine 2"x2 $\frac{1}{2}$ "x2' 4"
 1 piece ash or yellow pine $\frac{7}{8}$ "x2 $\frac{1}{2}$ "x3' 4"
 2 pieces ash or yellow pine $\frac{7}{8}$ "x2 $\frac{1}{4}$ "x8' 0"
 1 piece ash or yellow pine $\frac{7}{8}$ "x2"x3' 0"
 Hardware—44 flat head bright wood screws 2" No. 12
 3, $\frac{1}{4}$ " carriage bolts, 1—5 $\frac{1}{4}$ ", 1—5 $\frac{3}{4}$ ", 1—6 $\frac{1}{4}$ "

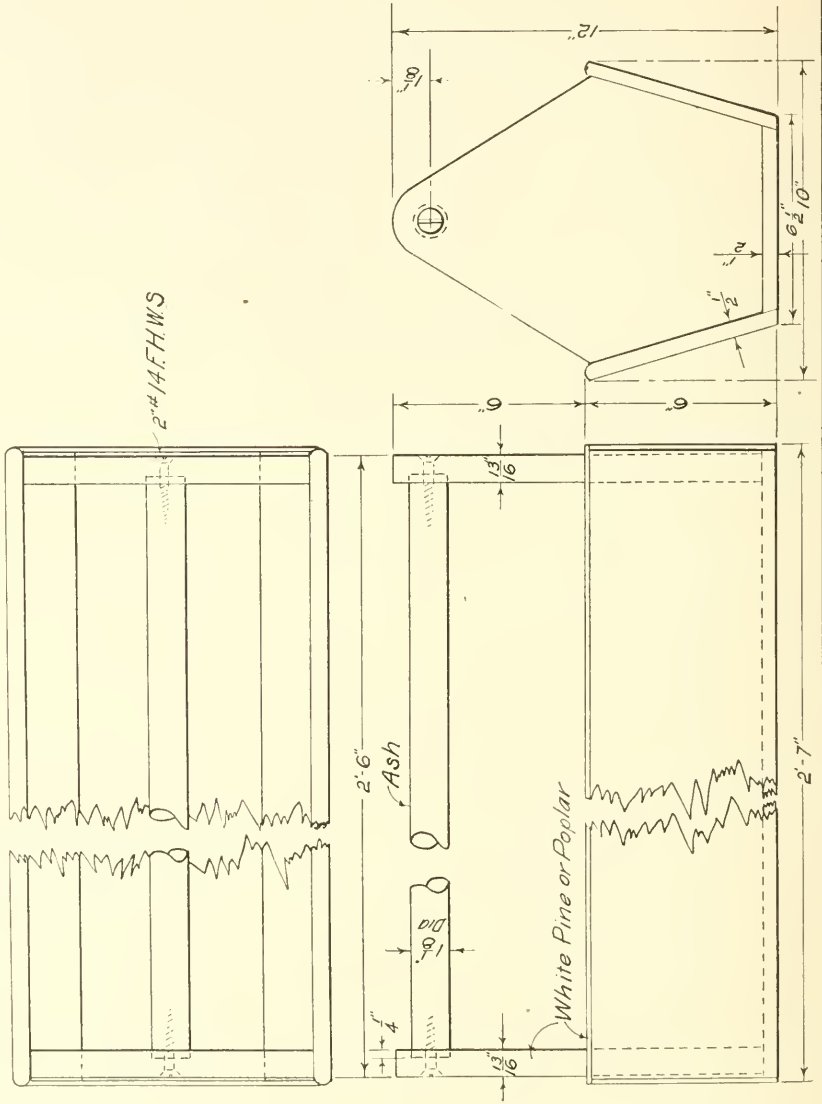
Stock Bill.

Pieces	Finished Dimensions	Use
2	1 $\frac{3}{4}$ "x3 $\frac{3}{4}$ " at foot and 2 $\frac{1}{2}$ " at top x 14' 0"	Stringers
1	1 $\frac{3}{4}$ "x2 $\frac{1}{2}$ "x2' 4"	Top
1	$\frac{7}{8}$ "x2 $\frac{1}{2}$ "x3' 4"	Bottom Rung
7	$\frac{7}{8}$ "x2 $\frac{1}{4}$ " x length of various middle rungs	Middle Rungs
3	$\frac{7}{8}$ "x2" x length of 3 top rungs	Top rungs

Directions.

1. Taper the stringers to 2 $\frac{1}{2}$ " at the upper ends.
2. Draw a line around top piece 12" from bottom end and from this line lay out a taper so that upper end of stock will be 1" thick x 2" wide.
3. Place the stringers on the floor or bench in the position which they are to assume when finished and lay out the bevel at the inside of the upper ends so as to fit snugly against the top. Remove the stock with a rip saw.
4. Place the bottom rung in position and set the T-bevel for laying out the gains in top of stringers.
5. Mark positions for gains in top of stringers and cut gains $\frac{3}{8}$ " deep and as wide as the rungs.
6. Place top in position and bore three $\frac{1}{4}$ " holes in position shown in drawing and bolt top in place.
7. Cut bottom rung to length and fasten with two 2" No. 12 screws at each end.
8. Cut all other rungs to length and fasten same as bottom rung.

Carpenters Tool Box



CARPENTER'S TOOL BOX

Material Required.

- Lumber—1 piece white pine or poplar 1''x9''x24''
 1 piece white pine or poplar $\frac{1}{2}$ ''x7''x5' 2''
 1 piece white pine or poplar $\frac{1}{2}$ ''x6''x2' 7''
 1 piece ash, maple or oak 1 $\frac{1}{8}$ '' round x 2' 6''
- Hardware— 2 flat head bright wood screws 2'' No. 14
 30 8d finishing nails

Stock Bill.

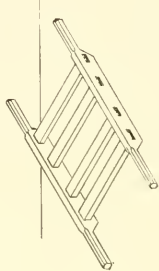
Pieces	Finished Dimensions	Use
2	13/16''x9''x12''	Ends
1	$\frac{1}{2}$ ''x5 $\frac{3}{4}$ ''x2' 7''	Bottom
2	$\frac{1}{2}$ ''x6 $\frac{3}{8}$ ''x2' 7''	Sides
1	1 $\frac{1}{8}$ '' round x 2' 4 $\frac{7}{8}$ ''	Handle

Directions.

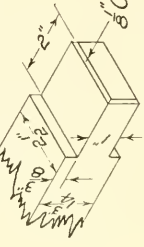
1. Reduce all pieces to finished dimensions.
2. Draw a centerline lengthwise of both end pieces.
3. On centerline just drawn swing an arc with a 1 $\frac{1}{8}$ '' radius, 1 $\frac{1}{8}$ '' from upper end.
4. Draw lines across both edges 6'' from end and connect points with lines drawn tangent to arc.
5. Draw two lines across lower end 2 $\frac{7}{8}$ '' from center and connect points with lines on edge of stock.
6. Remove stock to line with saw and plane, rounding the upper end with chisel.
7. At a point on centerline 1 $\frac{1}{8}$ '' from upper end bore a 1 $\frac{1}{8}$ '' hole $\frac{1}{4}$ '' deep on one side of each end piece for end of handle.
8. Bevel both edges of the bottom and the lower edge of both sides at the same angle as has been established at bottom and side of end pieces.
9. Round the upper edges of sides and ends of side pieces as indicated in the drawing.
10. Bore a $\frac{1}{4}$ '' hole through each end piece at same point as 1 $\frac{1}{8}$ '' hole and countersink hole on outside for head of screw.
11. Place handle in position, bore a hole in each end for screw and place screws.
12. Fasten bottom to ends using three 8d finishing nails at each end.
13. Fasten sides by using three nails at each end and six at the bottom.

Two-Man Weight Carrier

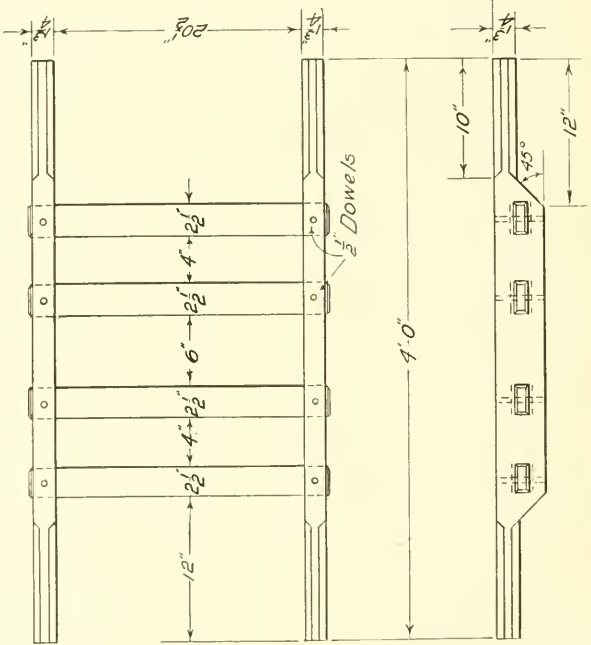
To lay out octagon



Detail of Tenon



3/8" Chamfer



TWO-MAN WEIGHT CARRIER

Material Required.

Lumber—1 piece of oak, maple, birch or other hard wood, 2"x8"x8' 0"
 1 piece of $\frac{1}{2}$ " maple doweling 34" long

Stock Bill.

Pieces	Finished Dimensions	Use
2	$1\frac{3}{4}$ "x4"x4' 0"	Arms
4	$1\frac{3}{4}$ "x2 $\frac{1}{2}$ "x24"	Cross pieces

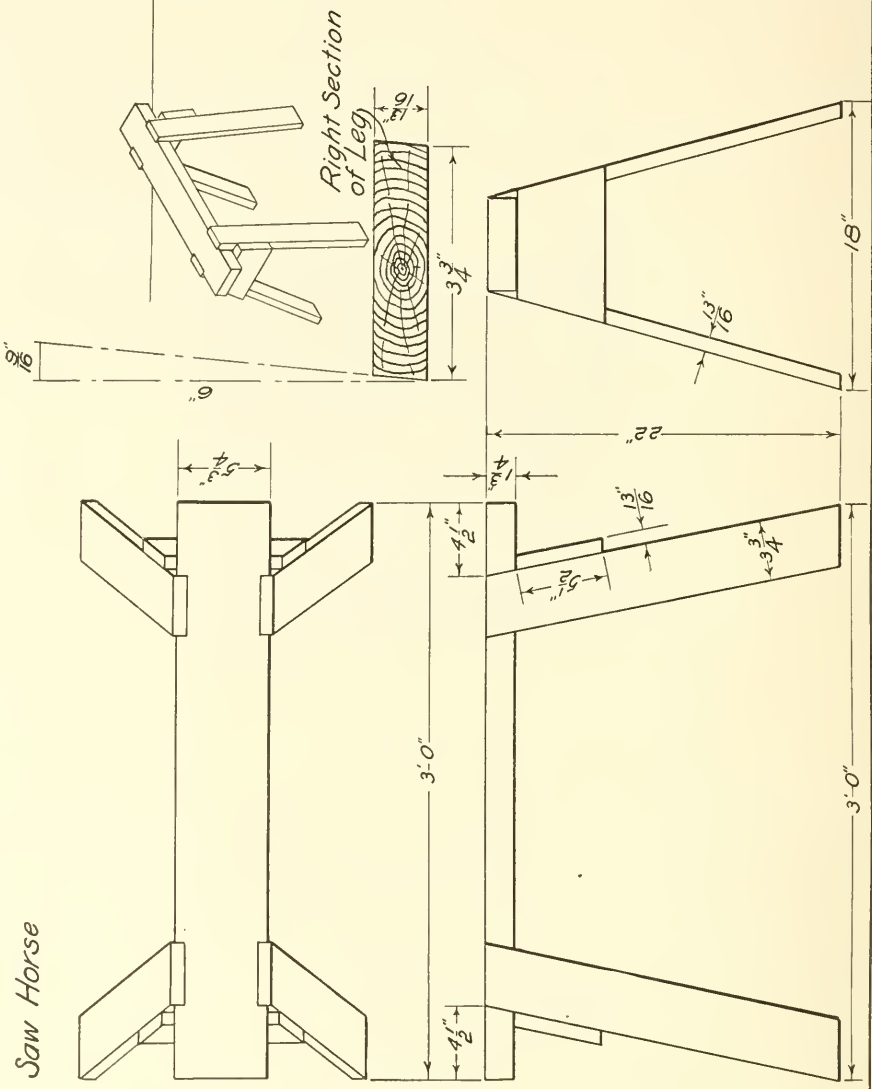


Fig. 33. Two-Man Weight Carrier.

Directions.

1. Reduce all pieces to finished dimensions.
2. To lay out handle draw a line across edge of arm 12" from end and from this line draw a 45° line on both sides of stock to meet line drawn lengthwise of stock $1\frac{3}{4}$ " from the upper edge. Remove the stock to line with a rip saw.
3. Lay out an octagon on end of arm using the method shown in detail drawing and remove the stock for chamfers with chisel, mallet and drawknife. The handles may be rounded by removing edges with plane and chisel if so desired.
4. Lay out mortises on both sides of arms for tenons at ends of cross pieces, mortises to be 1"x2 $\frac{1}{2}$ " with top of mortise $1\frac{1}{4}$ " from upper edge of arms, mortises to be spaced as shown in top view.
5. Draw a centerline lengthwise of mortises and remove stock with a 1" bit, chisel and mallet.
6. Lay out and cut tenons at ends of cross pieces to measurements shown in detail drawing and cut a $\frac{1}{8}$ " chamfer at end of tenon.
7. Assemble the carrier, draw joints up tight and bore $\frac{1}{2}$ " holes for dowels through arms and center of tenons.
8. Place dowels in position.

Saw Horse



SAW HORSE

Material Required.

- Lumber—1 piece white or yellow pine $1\frac{3}{4}'' \times 6'' \times 3' 0''$
 1 piece white or yellow pine $13/16'' \times 4'' \times 8' 0''$
 1 piece white or yellow pine $13/16'' \times 6'' \times 20''$
 Hardware—24 flat head bright wood screws $1\frac{3}{4}''$ No. 10

Stock Bill.

Pieces	Finished Dimensions	Use
1	$1\frac{3}{4}'' \times 5\frac{3}{4}'' \times 3' 0''$	Top
4	$13/16'' \times 3\frac{3}{4}'' \times 25\frac{1}{4}''$	Legs
2	$13/16'' \times 5\frac{1}{2}'' \times 10''$	Braces

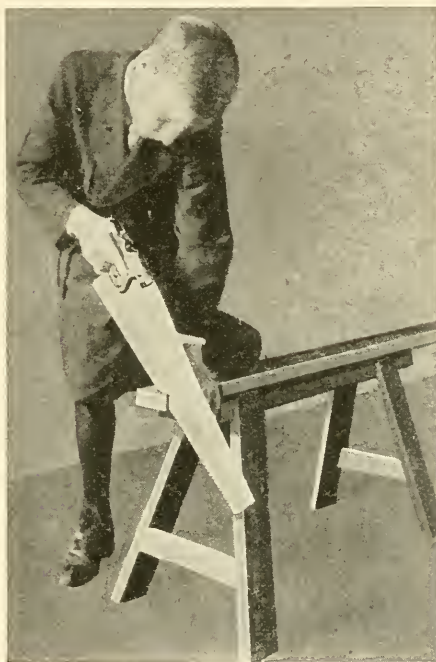
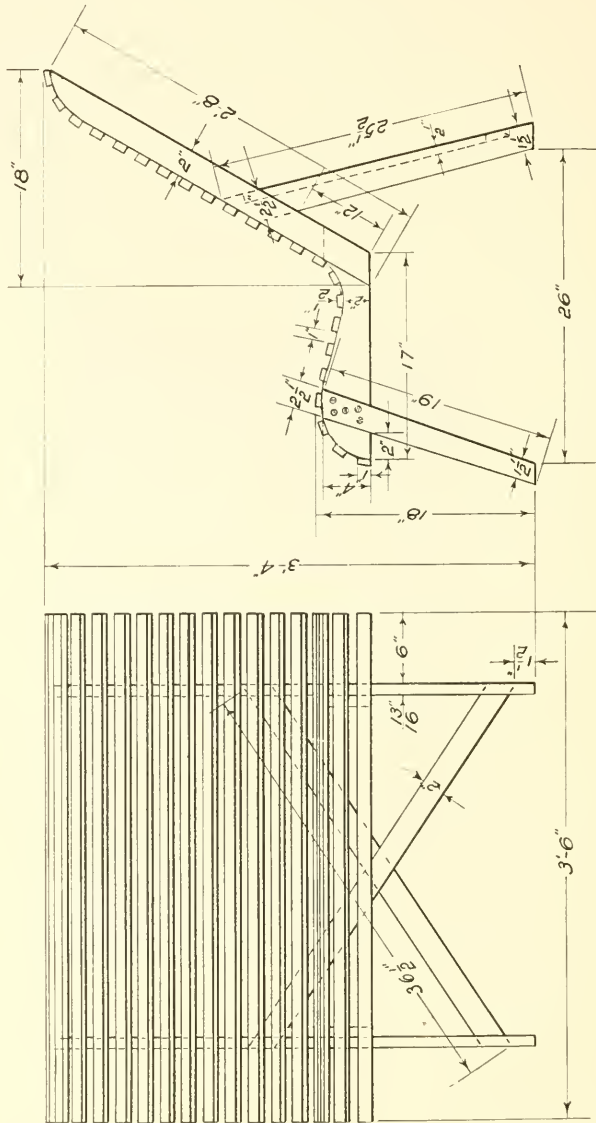


Fig. 34. Saw Horse in Use.

Directions.

1. Reduce all pieces to finished dimensions.
2. Lay out the bevels at the ends of the legs with the T-bevel and remove stock to line with saw.
3. Bevel the edges of the legs at the angle shown in the detail drawing.
4. Lay out and cut openings in the top for the legs $\frac{1}{2}''$ deep at the top with the T-bevel set at the same angle as for the ends of the legs.
5. Lay out and cut the bevels at the ends of the braces.
6. Bevel the edges of the braces so that they fit tightly against the top.
7. Assemble the parts by placing the screws as indicated in the drawing.

Lawn or Porch Seat



LAWN OR PORCH SEAT

Material Required.

- Lumber—1 piece basswood or white pine 13/16''x8''x8' 0''
 1 piece basswood or white pine 1/2''x10''x14' 0''
- Hardware—30 round head blued screws 1 1/2'' No. 9
 46 flat head bright wood screws 1 1/4'' No. 8

Stock Bill.

Pieces	Finished Dimensions	Use
2	13/16''x2 1/2'' tapered to 1 1/2''x19''	Back Legs
2	13/16''x2 1/2'' tapered to 1 1/2''x19''	Front Legs
2	13/16''x4''x19''	Seat Supports
2	13/16''x2''x2' 8''	Back
2	1/2''x2''x36 1/2''	Braces
23	1/2''x1''x3' 6''	Seat and Back Strips

Directions.

1. Reduce all pieces to finished dimensions.
2. Taper the legs from 2 1/2'' at the upper ends to 1 1/2'' at the lower ends and remove stock to line with the plane.
3. Lay out the bevel cut for the ends and remove stock with the saw.
4. Lay out the curve for the seat supports and the upper end of the back freehand and remove the stock with the drawknife.

5. Place the back legs on the bench in the position which they are to assume when the bench is assembled and mark the openings for the braces by placing them in the position indicated in the drawing. Also mark the pieces for the half lap joint where they cross each other. In making the gains make saw kerfs about 1/8'' apart to the depth of the opening and remove the stock with a wide chisel.

6. Assemble the seat in the following order: seat supports to back, front legs to seat supports, back legs to seat supports, braces, then seat and back strips. Five 1 1/2'' No. 9 round head blued screws should be used at each joint of legs and back; one flat head bright wood screw 1 1/4'' No. 8 at each end of the braces and strips.



Fig. 35. Lawn or Porch Seat.

DAILY MILK RECORD SHEET CASE

The ordinary way of keeping a milk record sheet is that of tacking it to a wall in the barn and making the record at milking time. The result is a soiled sheet which must be recycled before it can be put on file.

The purpose of the daily milk record sheet case is to provide a place for keeping the record sheet clean as the record is made and hence dispensing with recopying for a permanent record and also to reduce the possibility of error to a minimum.

Material Required.

- Lumber—1 piece of any soft wood 1''x8''x18''
 1 piece of any soft wood $\frac{1}{2}$ ''x6''x4' 0''
 1 piece of any soft wood $\frac{1}{2}$ ''x7''x3' 0''
- Hardware—1 piece tin, 1C, 17 $\frac{1}{2}$ ''x16 $\frac{1}{8}$ ''
 1 $\frac{1}{4}$ '' rod 20'' long
 6 $\frac{1}{4}$ '' washers
 2 $\frac{1}{4}$ '' nuts
 1 $\frac{1}{4}$ '' thumb nut
 3 8d finishing nails
 42 4d finishing nails
 24 $\frac{3}{4}$ '' No. 17 lining nails
 9 thumb tacks

Stock Bill.

Pieces	Finished Dimensions	Use
3	$\frac{3}{4}$ ''x5 $\frac{3}{4}$ '' diameter	Cylinder
1	$\frac{1}{2}$ ''x7''x17 $\frac{5}{8}$ ''	Bottom
2	$\frac{1}{2}$ ''x5 $\frac{1}{2}$ ''x6''	Ends
2	$\frac{1}{2}$ ''x5 $\frac{1}{2}$ ''x17 $\frac{5}{8}$ ''	Sides
2	$\frac{1}{2}$ ''x3 3/16''x17 $\frac{5}{8}$ ''	Top
1	$\frac{3}{4}$ ''x1''x16 $\frac{1}{8}$ ''	Brace

Directions.

1. With band saw, turning saw or coping saw, saw out the 5 $\frac{3}{4}$ '' cylinders.
2. Reduce all other pieces to dimensions.
3. Bore $\frac{1}{4}$ '' holes through center of cylinders.
4. Lay out opening for brace in cylinders $\frac{3}{4}$ '' deep and 1'' wide and remove stock with handy saw and coping saw.
5. Thread 2 $\frac{3}{4}$ '' of one end of the rod and bend 1'' of opposite end at a right angle.
6. Place ends of box, washers, nuts and cylinders on rods as indicated in the drawing.
7. Bend $\frac{1}{4}$ '' of one of the 16 $\frac{1}{8}$ '' edges of the tin as shown in the detail drawing, clamp tin at X with the brace and fasten brace in position with one 8d finishing nail in each cylinder.
8. Fasten tin to cylinders with lining nails spaced about 3'' apart and nail end of tin to brace.
9. Nail sides of box to ends, using three 4d finishing nails at each joint.
10. Nail bottom of box to sides and ends.
11. Lay out a 2'' bevel on top pieces as indicated in end view of drawing and remove stock with plane.
12. Nail top pieces in place.
13. Fasten one end of daily record sheet to brace with three thumb tacks, loosen the thumb nut and with other end of rod as a crank turn cylinder one revolution and fasten other end of sheet with two thumb tacks, lock cylinder in place with thumb nut.
14. Write the names of cows on a sheet of paper similar to the headings on the record sheet and fasten in position indicated in the drawing with two thumb tacks. A piece of scrap paper should be fastened to the top at front with two thumb tacks so as to keep the top of box clean.

AGRICULTURAL WOODWORKING

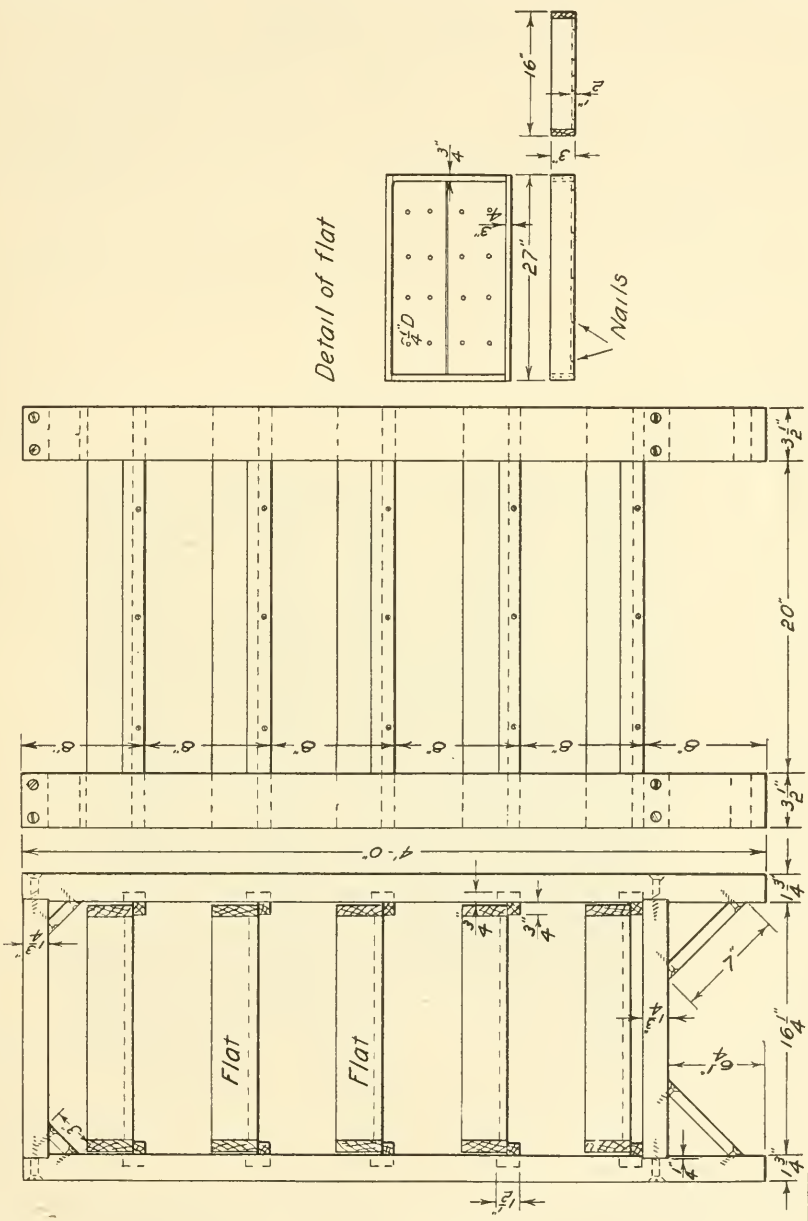
MEADOW BROOK DAIRY FARM
MILK RECORD FOR MONTH OF ---- 19--

	Dutchess	Vermont	Flora	Patsy	Topsy	Floss	Rosebud	Bright	Primrose	Pearl	Prudence	Nell	White-Cap	Polly	Brindle	June	Blossom	Beauty	Princess	Star	Kitty	Ginger	Queen	Pet	Molly	May Belle	Spot	Bonny	Fairy	Tanny		
																															Lbs	Lbs
1	AM																															
	PM																															
2	AM																															
	PM																															
3	AM																															
	PM																															
4	AM																															
	PM																															
5	AM																															
	PM																															
6	AM																															
	PM																															
7	AM																															
	PM																															
8	AM																															
	PM																															
9	AM																															
	PM																															
10	AM																															
	PM																															
11	AM																															
	PM																															
12	AM																															
	PM																															
13	AM																															
	PM																															
14	AM																															
	PM																															
15	AM																															
	PM																															
16	AM																															
	PM																															
17	AM																															
	PM																															
18	AM																															
	PM																															
19	AM																															
	PM																															
20	AM																															
	PM																															
21	AM																															
	PM																															
22	AM																															
	PM																															
23	AM																															
	PM																															
24	AM																															
	PM																															
25	AM																															
	PM																															
26	AM																															
	PM																															
27	AM																															
	PM																															
28	AM																															
	PM																															
29	AM																															
	PM																															
30	AM																															
	PM																															
31	AM																															
	PM																															
TOTAL																																

16 1/2"

Form for Daily Milk Record Sheet.

Oats Sprouter



Detail of flat

OATS SPROUTER

Material Required.

Lumber—1 piece 2''x4''x10' 0'' white pine, cypress, fir
 1 piece 2''x4''x12' 0'' white pine, cypress, fir
 2 pieces 1''x8''x12' 0'' white pine, cypress, fir
 2 pieces $\frac{1}{2}$ ''x8''x12' 0'' white pine, cypress, fir

Hardware—16 flat head bright wood screws 3'' No. 14
 16 flat head bright wood screws $1\frac{1}{4}$ '' No. 9
 30 flat head bright wood screws $1\frac{1}{4}$ '' No. 7
 1 lb. 6d common nails

Stock Bill.

Pieces	Dimensions	Use
4	$1\frac{3}{4}$ ''x $3\frac{1}{2}$ ''x4' 0''	Posts
4	$1\frac{3}{4}$ ''x $3\frac{1}{2}$ ''x $16\frac{3}{4}$ ''	Cross bars
4	$\frac{3}{4}$ ''x $3\frac{1}{2}$ ''x7''	Lower braces
4	$\frac{3}{4}$ ''x $3\frac{1}{2}$ ''x3''	Upper braces
10	$\frac{3}{4}$ ''x $\frac{3}{4}$ ''x2' 3''	Rests for flats
10	$\frac{3}{4}$ ''x $1\frac{1}{2}$ ''x20''	Guides for flats
10	$\frac{3}{4}$ ''x3''x2' 3''	Sides of flats
10	$\frac{3}{4}$ ''x3''x16''	Ends of flats
10	$\frac{1}{2}$ ''x $7\frac{1}{8}$ ''x2' $1\frac{1}{2}$ ''	Bottoms of flats

Directions.

1. Reduce all pieces to finished dimensions.
2. Cut two gains across one side of each post $1\frac{3}{4}$ '' wide, $\frac{1}{4}$ '' deep; one at the top end and the other $6\frac{1}{4}$ '' from the lower end.
3. Bore and countersink holes for the 3'' No. 14 screws and assemble the framework, placing two screws at each joint.
4. Mitre the ends of the braces at a 45° angle, bore and countersink holes for screws and fasten braces in place. Use a square in assembling the framework and make the corners square. An angle of 45° may be obtained by using any two equal figures on the steel square, one on the beam and the other on the blade.

5. Fasten the rests for flats by using two 6d common nails at each end of each piece.

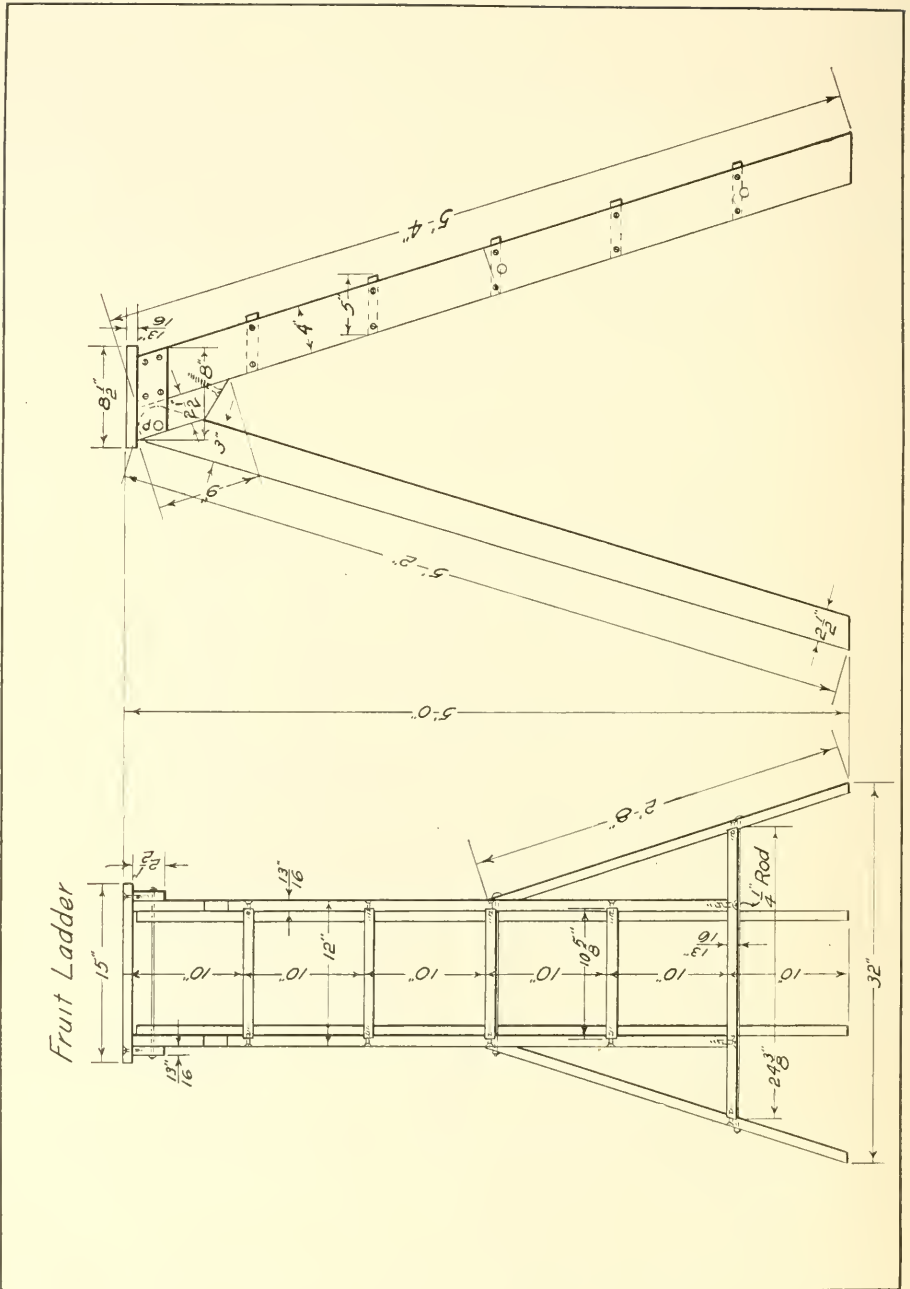
6. Fasten the guides to the rests by placing three $1\frac{1}{4}$ " No. 7 screws in each piece as indicated in the drawing.

7. Assemble the flats by driving three 6d common nails through each end of each side piece, four nails through the end piece into the bottom, and five nails through each side into the bottom; spaced as in detail of flat.

8. A space of $\frac{1}{4}$ " should be left between the two pieces for the bottom and $\frac{1}{4}$ " holes bored as shown in the drawing, to permit proper drainage.



Fig. 36. Oats Sprouter.



FRUIT LADDER

Material Required.

- Lumber—2 pieces white or Norway pine 13/16"x4"x8' 0"
 1 piece white or Norway pine 13/16"x8½"x12' 0"
 Hardware—3½ doz. flat head bright wood screws 1½" No. 9
 1 ¼"x26½" rod with washers
 1 ¼"x14" rod with washers
 1 ¼"x13" rod with washers

Stock Bill.

Pieces	Finished Dimensions	Use
2	13/16"x4"x4' 2"	Standards
2	13/16"x3" tapered to 2½"x5' 2"	Back standards
1	13/16"x8½"x15"	Top
2	13/16"x2½"x9"	Upper rod braces
2	13/16"x2½"x8"	Cleats
1	13/16"x5"x24⅜"	Bottom step
4	13/16"x5"x10⅝"	Steps
2	13/16"x4"x2' 8"	Braces

Directions.

1. Reduce all pieces to finished dimensions.
2. Set the T-bevel for the end cuts of the main standards by placing it on the drawing or by using 2 and 6¼ on the steel square. Lay out the end cuts of standards and braces and remove the stock.
3. With the T-bevel set at the same angle as for the end cuts, lay out the dado ⅜" deep in the braces and standards for each end of each step.
4. Draw a centerline at the upper end of the front standards, and from a point on centerline 1½" from the end swing an arc and remove stock to the arc.
5. With the T-bevel set as for the standards bevel the edges of the steps and the ends of the bottom step.
6. With the T-bevel set as for the standards lay out the ends of cleats and remove the stock with the saw.
7. Lay out the lower end of the front standard with the T-bevel and remove the stock with the saw.
8. Lay out the slant at the lower end of the upper rod braces and remove the stock with the saw.
9. Fasten the bottom step to the lower end of the standards by using two 1½" No. 9 screws at each joint.
10. Fasten the other four steps in similar manner.
11. Fasten cleats and upper rod braces by placing screws as shown in the drawing.
12. Use 6 screws for the top, driving them into the cleat.
13. The heads of the rods may be bent at a right angle at ½" from the end if rods of this length with heads are not available. A washer should be used at each end.

WAGON BOX

Material Required.

- Lumber—2 pieces poplar or basswood 2''x4''x10' 0''
 2 pieces poplar or basswood 1''x12''x12' 0''
 4 pieces poplar or basswood 1''x9''x12' 0''
 1 piece poplar or basswood 1''x11''x6' 0''
 1 piece poplar or basswood 1''x10''x10' 0''
- Hardware—8 wagon box strap bolts
 8 wagon box side braces
 2 wagon box rods
 2 dash braces
 2 rub irons
 36 carriage bolts $\frac{3}{8}$ ''x3 $\frac{1}{2}$ '' for floor and running boards.
 8 carriage bolts $\frac{3}{8}$ ''x2 $\frac{1}{2}$ '' for floor
 24 carriage bolts $\frac{3}{8}$ ''x2 $\frac{1}{2}$ '' for side and end cleats.
 38 carriage bolts $\frac{1}{4}$ ''x1 $\frac{1}{2}$ '' for strap bolts, side braces and rub irons
 4 carriage bolts $\frac{1}{4}$ ''x2 $\frac{1}{2}$ '' for dash braces
 2 carriage bolts $\frac{1}{4}$ ''x2'' for dash braces

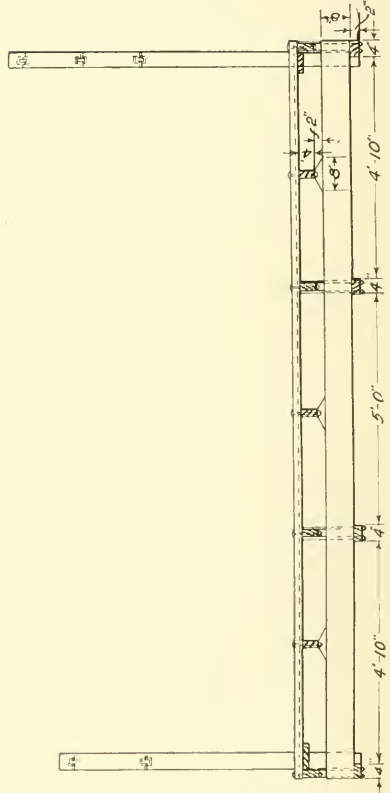
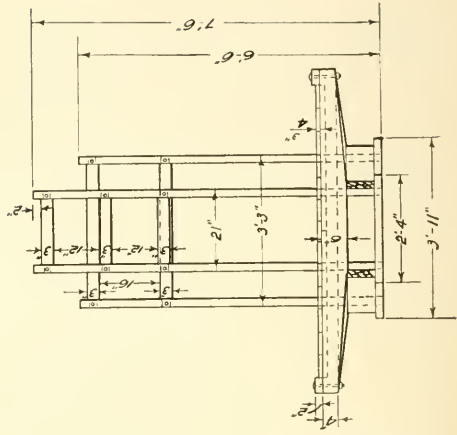
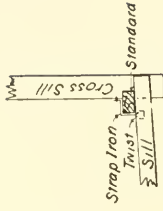
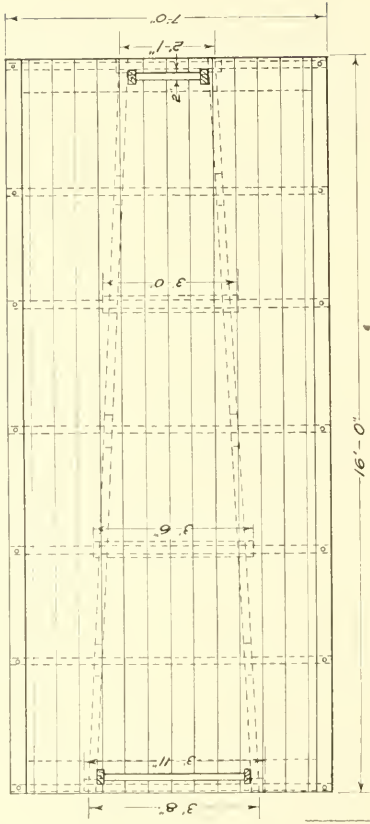
Stock Bill.

Pieces	Finished Dimensions	Use
4	2''x 4''x 4' 2''	Cross sills
2	1''x 3''x 3' 2''	Cross sills
2	1''x12''x12' 0''	Sides
2	1''x11''x 3' 0''	End gates
4	1''x 9''x12' 0''	Floor
2	1''x 3''x 3' 0''	Running boards
1	1''x 8''x 3' 2''	Dash board
12	1''x 2''x11''	End and sideboard cleats

Directions.

1. Reduce all pieces to finished dimensions.
2. Fasten floor to cross sills by using eight $\frac{3}{8}$ ''x3 $\frac{1}{2}$ '' carriage bolts for each board, two through each sill. All nuts should be locked by slightly marring the thread with a cold chisel.
3. Fasten wagon box trap bolts in place on side boards and bolt in place through cross sills.
4. Bolt running boards in place, using one $\frac{3}{8}$ ''x3 $\frac{1}{2}$ '' carriage bolt at each end of each board, through the cross sills.
5. Fasten wagon box side braces in positions indicated in the drawing.
6. Fasten rub irons in place at edges of box.
7. Fasten cleats to side boards and rear end gate by using two $\frac{3}{8}$ ''x2 $\frac{1}{2}$ '' carriage bolts for each cleat.
8. Bevel the lower edge of the dash board and fasten to front end gate by bolting dash braces in place. The two bolts which hold the lower ends of the dash braces should pass through the end gate cleats.
9. Fasten the rear axle cross rests in place, using one $\frac{3}{8}$ ''x2 $\frac{1}{2}$ '' carriage bolt for each board through each rest.

Flat Hay Rack



FLAT HAY RACK

Material Required.

- Lumber—2 pieces yellow pine 2''x8''x16' 0''
 3 pieces yellow pine 2''x4''x14' 0''
 3 pieces yellow pine 2''x4''x12' 0''
 2 pieces yellow pine 2''x4''x16' 0''
 1 piece yellow pine 2''x4''x8' 0''
 2 pieces yellow pine 2''x6''x14' 0''
 1 piece yellow pine 2''x2''x3' 0''
 1 piece yellow pine 1''x6''x14' 0''
 13 pieces yellow pine flooring 13/16''x6''x16' 0''
- Hardware—8 hayrack clamps 16½'' long
 14 carriage bolts ¾''x6½''
 1 lb. 10d common nails
 4 pieces strap iron ¾''x1''x7''
 1 quart of outside paint

Stock Bill.

Pieces	Finished Dimensions	Use
2	2''x8''x16' 0''	Sills
1	2''x4''x3' 11''	Cross tie
1	2''x4''x3' 6''	Cross tie
1	2''x4''x3' 0''	Cross tie
1	2''x4''x2' 1''	Cross tie
4	2''x6''x7' 0''	Arms
3	2''x4''x7' 0''	Arms
6	2''x2''x0' 6''	Arm rests
2	2''x4''x7' 6''	Front standard
2	2''x4''x6' 6''	Rear standard
3	2''x4''x0' 21''	Front standard
2	2''x4''x3' 3''	Rear standard
2	2''x4''x16' 0''	Side supports
4	13/16''x6''x3' 2''	Platform cleats
13	¾''x6''x16' 0''	Floor

Directions.

1. Reduce all pieces to finished dimensions.
2. Bore holes through main sills and cross ties for hay rack clamps and fasten the 2''x6'' arms in place. If patented clamps are used holes need not be bored through the sills, as they straddle the sills. Clamps may be made of ¾'' round iron.
3. Nail the clamp rests in place half way between the 2''x6'' arms.
4. Place side supports in position at the ends of the cross sills, bore ¾'' holes and place one ¾'' carriage bolt through each end of each arm.
5. The platform is made in two sections, half of the floor boards being fastened together for one section and half for the other. Fasten the floor boards to the platform cleats by using two 10d common nails for each end of each board.
6. Mortise the cross members of both front and rear standards to the uprights of the standards, in positions indicated in the drawing, and fasten with dowels or screws.
7. Cut a shoulder at the lower ends of the standards so that the standards will rest on the front and rear cross sills.
8. Fasten a piece of strap iron to the lower edge of the main stringers and the inside edge of the front and rear cross sills as shown in the detail drawing for the lower end of the standard to drop into.
9. Cut openings through the floor for the standards.
10. Paint the hayrack.

CARPENTER'S WORK BENCH

Material Required

Lumber—1 piece 2''x10''x10' 0'' maple
 1 piece 2''x8''x2' 8'' maple
 2 pieces 2''x10''x10' 0'' select white pine
 1 piece 2''x4''x16' 0'' select white pine
 1 piece 2''x4''x3' 0'' maple
 1 piece 2''x6''x10' 0'' No. 1 white pine
 3 pieces 1''x10''x10' 0'' No. 1 white pine
 1 piece ½''x8''x12' 0'' No. 1 white pine
 1 piece 1''x10''x2' 0'' maple

Hardware—18 carriage bolts ¾''x7'' with washers
 12 carriage bolts ¾''x4¼'' with washers
 1 carriage bolt ¾''x4¼'' with washers
 42 flat head, bright screws 2'' No. 12
 15 flat head, bright screws 1½'' No. 10
 1 16''—1¼'' bench screw
 1 iron pin ½''x4½''

Stock Bill

Pieces	Finished Dimensions	Use
1 maple	1¼''x10''x10' 0''	Top
2	1¾''x10''x10' 0''	Top
1 maple	1¾''x3¾''x2' 8¼''	Leg
5	1¾''x3¾''x2' 8¼''	Legs
3	1¾''x5¾''x2' 2¾''	Cross rests
2	¾''x9¾''x10' 0''	Side aprons
1	¾''x8''x2' 2¾''	Shelf
2	¾''x1½''x8''	Shelf rests
3	¾''x3¾''x2' 2¾''	Leg braces
2	¾''x3¾''x1' 5¾''	Braces
2	¾''x2''x1' 9½''	Cross shelf rests
1	¾''x7''x2' 0''	Drawer front
2	½''x7''x23¼''	Drawer sides
1	½''x6''x23''	Drawer back
2	½''x8''x23¾''	Drawer bottom
1	½''x7''x23¾''	Drawer bottom
2	¾''x3''x2' 2¾''	Drawer rests
1	1¾''x7¾''x2' 7''	Vise
1	¾''x5¾''x16''	Vise
1	¾''x2¾''x16''	Vise lock
1	¾''x3¾''x6''	Bench stop

Directions

1. Reduce all pieces to finished dimensions.
2. Lay out and cut notches 1''x5¾'' on one edge at one end of each leg to receive the cross rests.
3. Lay out and cut out the dadoes ½''x3¾'' on the legs for the leg braces, 6'' from the lower end of each leg.
4. Lay out the vise to a 3¾'' taper at the lower end and 6'' at the upper end and remove the stock to line with saw and plane.
5. Lay out and cut a ¼'' chamfer on one side of the vise at both ends and both edges.
6. Taper the front piece for the vise to 3¼'' at each end.
7. Chamfer the front piece the same as main piece for vise.
8. Bore ⅝'' holes for ½'' iron peg in the vise lock at points shown in section drawing.
9. Lay out and cut an opening at center of lower end of vise ¾''x2¾'' to receive the vise lock and fasten vise lock in place with a ¾''x1¼'' carriage bolt.
10. Lay out and cut a mortise in the maple leg; the mortise to be 15/16''x2 13/16'' on a centerline, drawn lengthwise of the stock; the upper end of the mortise to be 6'' from the lower end of the leg.
11. Fasten the front support of the vise to the main piece by using four 1½'' No. 10, flat-head, bright wood screws; heads of screws to be neatly countersunk.
12. Locate a point on a centerline, drawn lengthwise of the vise 10'' from the upper end of the stock, and bore a 1'' hole for the bench screw.
13. Fasten bench screw in place on the vise.
14. Fasten the cross rests to the legs by using two ¾''x4¼'' carriage bolts at each joint.
15. Place the leg braces in position and fasten with two 2'' No. 12 wood screws at each joint.
16. Fasten braces in position using two screws at each leg.

17. Fasten cross shelf rests using two 2" No. 12 screws thru the braces into each end of each brace. The upper edge of rests and braces to be flush.

18. Place the aprons and fasten with three 2" No. 12 wood screws into each leg.

19. Cut two openings in the front apron; one to be 1"x2' 0" for a board support and the other to be 7" x2' 0" for the drawer. These openings to be cut at places indicated in the drawing.

20. At the end of bench opposite from the vise fasten the shelf rests at position shown in end elevation. Two 1½" No. 10, flat-head, wood screws should be driven through each rest and into the apron.

21. Lay the shelf on the shelf rest and fasten with two screws at each end.

22. Shape two pieces of stock 2' 2¼" long for drawer to slide on as shown in the front elevation and fasten in place by driving two 2" No. 12 wood screws through the aprons into each end.

23. Build a drawer to given dimensions. Stops should be placed so that the front edge of the drawer will close flush with the front apron.

24. Bore a 1" hole in the maple leg and through the apron for the bench screw; the hole to be on a centerline, drawn lengthwise of the stock 8¼" from the upper end of the leg. Cut keyway for the key on the nut of the bench screw and fasten nut in place with screws.

25. Bore a ⅝" hole through the maple leg for the iron pin.

26. Bore ¾" holes in the front apron for maple peg at points shown in front elevation.

27. Place top planks in position. Locate points for bolts as indicated in top plan. Bore holes in planks ½" deep large enough to drop the heads of bolts. Finish the holes with ⅜" bit through the planks and cross rests. Bolt top firmly in place.

28. Plug the bolt holes.

29. Make a maple bench stop to given dimensions and fasten with five 1¼" No. 8, flat-head bright wood screws; heads of screws to be countersunk below the surface of the stop.



Fig. 37. The Work Bench and Tools in Shop.



Fig. 38. Corner in Workshop. Note Forge and Tools.

A FARM WORKSHOP

A farm shop, suitable for the average farm, is illustrated on page 88. It was designed to meet ordinary needs without an unnecessary outlay of either material or equipment. The tools which make up the equipment, are those necessary for the ordinary farm and for keeping the equipment of such a farm in order. The individual must use good judgment in selecting standard tools, the size and weight of which suit his particular needs and the conditions which his particular farm presents.

The building is 16 feet by 20 feet with 12-foot posts. The joists for the attic are placed for a 9-foot ceiling. The roof is half pitch, providing a large attic for storage purposes. The door is 8 feet by 8 feet which is a convenient size for admitting all kinds of farm machinery and equipment. Two large windows have been placed at each side of the shop and one small one in each gable for the attic. A door 2 feet 6 inches by 3 feet has been built above the main door, to admit lumber into the attic. A stock of lumber should always be kept on hand on the attic shelves.

On one side, between the windows, a work bench 2 feet 6 inches wide, 10 feet long and 2 feet 10 inches high is built. The front end of the bench is equipped with a homemade wooden vise which has an iron bench screw. At the other end is fastened a metal vise. The top of the bench is made of three 2-inch by 10-inch planks, the front one of which is maple, the others pine. The woodworking tools are arranged on the wall over the work bench, within easy reach of the workman at the bench.

On the other side, at the rear corner, stand the forge and anvil. The forging tools hang on either the anvil block, or on the rack on the wall near the forge. On the same side, in the other corner, stands the stove. The smoke pipes from the stove and forge lead to the chimney, which is constructed of sewer tile and stands on a bracket. The chimney extends higher than the ridge of the building and is braced by rods. The drill press is fastened to the wall near the forge, and next to this is the grinder.

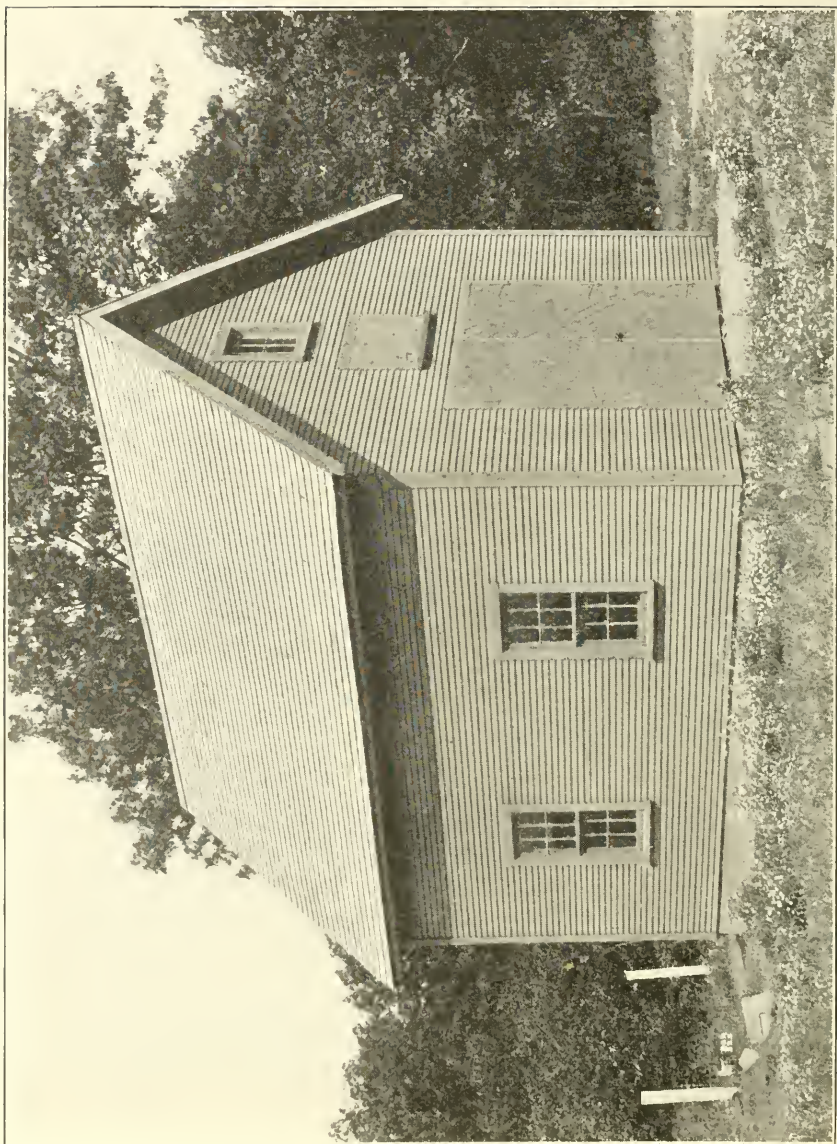
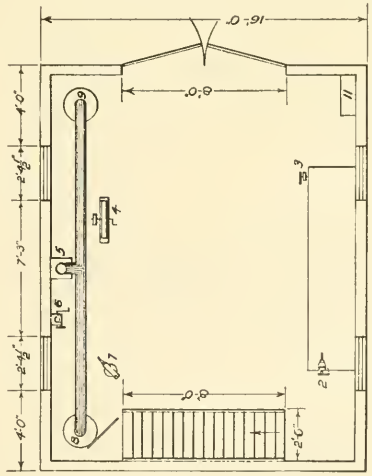
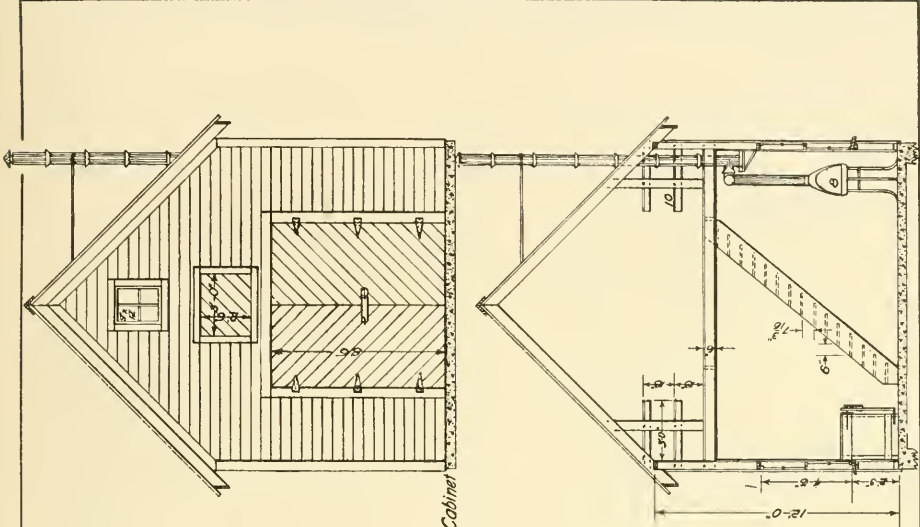
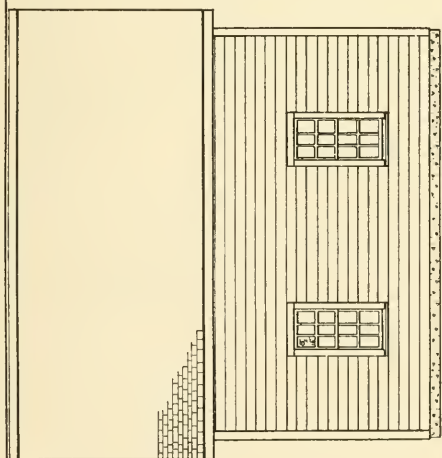


Fig. 39. The Farm Workshop at the Milwaukee County School of Agriculture.

Farm Shop

- 1 Work Bench
- 2 Machinists Vise
- 3 Wooden Vise
- 4 Grinder
- 5 Tile Chimney
- 6 Drill Press
- 7 Anvil
- 8 Forge
- 9 Stove
- 10 Attic Shelves
- 11 Screw, Nail & Bolt Cabinet



Plan of Farm Workshop.

The remaining wall space is sufficient for conveniently hanging all the farm tools. A silhouette of each is painted on the wall in its proper place so that when a tool is missing one can easily detect what it is. In a corner is a waste box over which hangs a broom.

At the rear of the room is a stairway leading into the attic over which is a trap door. This door is manipulated by a rope hung over a pulley. This permits closing off the attic from the rest of the building in cold weather.

Lumber for Farm Shop.

9 pc. 2"x 4"—16' Hemlock or Y Pine
5 pc. 2"x 4"—20' Hemlock or Y Pine
3 pc. 2"x 4"—18' Hemlock or Y Pine
26 pc. 2"x 4"—14' Hemlock or Y Pine
38 pc. 2"x 4"—12' Hemlock or Y Pine
11 pc. 2"x 6"—16' No. 1 White Pine
3 pc. 2"x 8"—14' No. 1 White Pine
4 pc. 1"x12"—10' No. 1 White Pine
4 pc. 1"x12"—14' No. 1 White Pine
10 pc. 1"x 6"—12' No. 1 White Pine
10 pc. 1"x 6"—14' No. 1 White Pine
5 pc. 1"x 6"—10' No. 1 White Pine
7 pc. 1"x 4"—12' No. 1 White Pine
14 pc. 1"x 4"—10' No. 1 White Pine
22 pc. 1"x10"—10' No. 1 White Pine
3 pc. 1"x 8"—14' No. 1 White Pine
1160 ft. No. 1 White pine drop siding.
1585 ft. No. 1 White pine matched fencing 6"
500 ft. Hemlock roof boards
6000 *A* Shingles

Hardware for Farm Shop.

12 lbs. 20d Nails
5 lbs. 10d Nails

60 lbs. 8d Nails
20 lbs. 3d Shingle Nails
6 12" Extra Heavy "T" Hinges
2 8" Heavy "T" Hinges
2 6" Strap Hinges
12 Window Spring Bolts
1 6" Hook with Staple
1 Barn Door Latch 7" long with Padlock
Hasps
1 Padlock
18 ½"x6" Carriage Bolts with Washers

Lumber for Work Bench for Farm Shop.

1 pc. 2"x10"—10' Maple
2 pc. 2"x10"—10' Select white pine
1 pc. 2"x4"—16' White Pine
3 pc. 1"x10"—10' White Pine No. 1
1 pc. 2"x6"—10' White Pine No. 1
1 pc. 1"x6"—16' White Pine No. 1
1 pc. 2"x8"—2' 8" Maple
1 pc. 2"x4"—3' Maple
1 pc. ½"x8"—12' White Pine
1 pc. 1"x10"—2' Maple

Carpentry Tools for Farm Shop.

1 26" Cross Cut saw.....	\$ 1.10	1 8" Triangular file.....	\$ 0.12
1 26" Rip Saw.....	1.10	1 6" Slim tapered triangular file.....	.10
1 Jack plane—14" with 2" cutter.....	1.80	1 12" Half-round wood file.....	.32
1 Carpenters' draw knife.....	.55	1 Pair 8" winged dividers.....	.55
1 Marking gauge.....	.15	1 8" Oblong carborundum oil stone.....	.85
1 8" Try Square.....	.25	1 16-oz. Straight claw hammer.....	.50
1 Mallet.....	.22	1 24" Carpenter's level.....	.90
1 Saw Set.....	.80	1 Nail set.....	.05
1 Set of Auger Bits, 4 16" to 16/16" inclusive.....	4.70	1 Putty knife.....	.15
1 Ratchet Brace.....	1.50	4 Socket firmer chisels—¼", ½", 1", 1½".....	1.40
2 Screwdrivers, 1 large, 1 small.....	.72	1 2-lb. 2-oz. Bench hatchet.....	.60
1 Countersink.....	.20	1 Myers Famous Lock Stitch, Sewing Awl with skein of thread and 1 doz. needles and 1 ball wax.....	.75
1 Steel rafter framing square.....	1.00	1 2-ft. four-fold boxwood rule.....	.25
1 Pair Pliers.....	.70		
1 10" Flat file.....	.15		

Total.....\$21.48

Blacksmithing Tools for Farm Shop.

Farmer's Anvil—70-lb., cast iron body, steel face.....	\$ 5.00	1 Bottom Fuller ½" to 9/16" with handle.....	\$ 0.40
Farmer's Forge.....	6.00	1 Square Flatter 1½" face with handle..	.15
Blacksmith's Hand Hammer—1-lb., 10-oz.....	.44	1 Set Hammer 1" Sq. Face with handle.....	.30
Machinist's Hammer, 1-lb., 8-oz.....	.37	1 Cold Cutter 1⅜" face with handle..	.50
1 Straight Lipped ¼" opening, 18" length blacksmith's tongs.....	.40	1 Hot Cutter 1⅜" face with handle...	.40
1 Bolt Tongs, ⅜" to ½", 20" length....	.50	1 No. 9 Star Hack Saw Frame with 1 doz. blades (12" frame and blades)	1.20
1 Pair Fluted Jaw Tongs for ¼" to 5/16" iron, 18".....	.50	1 Agricultural Wrench 2⅛" opening...	.60
1 Steel Square, 12"x8".....	.50	1 Always ready alligator wrench, 7" length.....	.80
1 Hardie to fit Farmer's Anvil.....	.35	1 5-lb. box cherry heat welding com- pound.....	.40
1 Bonney's Farmer's Vise.....	3.10	1 Spring Belt punch four tube.....	.75
1 No. 1 Silver's Blacksmith's Drill....	5.60	1 Scratch Awl.....	.10
1 Set Cleveland Twist Drill Bits, ⅛" to 1" by sixteenths (Shank to fit No. 1 Drill).....	4.25	1 Grinder with one coarse and one medium dimo grit wheel.....	8.50
1 10-lb. Blacksmith's Cross Pein Sledge.....	.60	1 Set of Stocks and Dies.....	4.00
1 Top Fuller ½" to 9/16" with handle..	.35	1 Copperized Oiler.....	.15
		1 14" Pipe Wrench.....	.75
Total.....			\$46.96

Farm Tools to be Stored in Farm Shop.

Crowbar, 10-lb.....	\$ 0.40	Hay fork, 4-ft. Handle.....	\$ 0.45
Corn Hook.....	.25	D. Handle Spade.....	.60
Scythe.....	.75	Garden Rake.....	.55
Snath.....	.70	Clover Rake.....	.50
Ax, 4-lb. (handled).....	.80	1 lb. High Grade Cup Grease.....	.20
Ironed Neckyoke.....	.55	Cant Hook (4-ft. handle).....	1.15
Singletree.....	.45	Heavy Bush Scythe.....	.75
Evener.....	.65	Bush Snath.....	.75
1 lb. Frazer Axle Grease.....	.10	Carborundum Scythe Stone.....	.18
Axle Oil.....	.22	Buck Saw.....	.50
Handled Cast Post Maul, Speery's Pattern, 16-lb.....	.65	Watering Pot, 16-quart.....	.38
1 Mill and Warehouse Broom.....	.43	Hay Knife (Weymouth).....	.70
Wire-stretcher, Benedict's Improved Jumbo.....	.65	Spading Fork.....	.65
Log Chain, 5/16" diam., 12 ft. length.	1.00	Manure Fork, 4-ft. Handle.....	.55
Post Hole Digger (Atlas).....	1.00	Harness Oil, 1 pint.....	.25
Mattock.....	.50	Ensilage Fork.....	1.15
One Man Cross Cut Saw (Champion Tooth), 4-ft.....	1.60	Sanderson Grain Scoop.....	.90
		Potato and Vegetable Scoop.....	1.10
		1 Bolster Spring, 1,000-lb. xxx.....	1.85
		1 Garden Hoe.....	.55
Total.....			\$24.41

ENSILAGE RACK

Material Required

- Lumber—2 pieces of white or yellow pine 6''x6''x16' 0''
 2 pieces of white or yellow pine 2''x6''x12' 0''
 1 piece of white or yellow pine 2''x6''x14' 0''
 1 piece of white or yellow pine 2''x4''x12' 0''
 2 pieces of white or yellow pine 1''x6''x10' 0''
 17 pieces of white or yellow pine 1''x10''x6' 0''
 1 piece of ash or white oak 2''x4''x3' 6''
 2 pieces of white or yellow pine 4''x4''x12''

- Hardware—2 U bolts $\frac{3}{4}$ '' round stock 4 $\frac{1}{4}$ '' inside, 16'' long with plate washers and nuts to carry stringers to rear axle.
- | | |
|--|-------------------------------|
| 1 eye bolt $\frac{3}{4}$ ''—8'' long | } To carry stringers at front |
| 1 triangular link $\frac{3}{8}$ '' stock, 4'' long | |
| 1 piece iron $\frac{3}{8}$ ''x2''x10'' for clevis at front end of reach | |
| 2 machine bolts $\frac{3}{8}$ ''x3'' to hold clevis to reach at front | |
| 1 piece iron $\frac{3}{8}$ ''x2''x16'' to hold rear end of reach | |
| 4 machine bolts $\frac{3}{8}$ ''x2 $\frac{1}{2}$ '' to fasten reach at rear | |
| 3 machine bolts, one $\frac{1}{2}$ ''x6'', one $\frac{1}{2}$ ''x9'', one $\frac{1}{2}$ ''x5'' to hold stringers together at front. | |
| 4 carriage bolts $\frac{1}{2}$ ''x8 $\frac{1}{2}$ '' to hold uprights to stringers at rear | |
| 2 carriage bolts $\frac{1}{2}$ ''x14'' to hold uprights to stringers at front | |
| 2 lbs. 8d common nails | |
| 16—16d nails | |

Stock Bill

Pieces	Finished Dimensions	Use
2	6''x6''x16' 0''	Stringers
4	2''x6''x5' 3''	End uprights
2	2''x6''x6' 0''	End cross pieces
2	2''x4''x5' 8''	Front end diagonal braces
2	1''x6''x9' 6''	Lower side cleats
17	1''x10''x6' 0''	Floor
1	2''x4''x3' 6''	Reach
2	4''x4''x12''	Blocks below rear axle
2	2''x6''x10''	Braces for front uprights

Directions

- Cut all pieces to dimensions called for in stock bill.
- Draw a line across one edge of each stringer 3' 4'' from the front end and a line across the front end of each 2'' from the outside edge. Connect the line across the end with the line across the edge and remove the stock with the rip saw.
- Bolt the stringers together at front with the $\frac{1}{2}$ ''x5'', $\frac{1}{2}$ ''x6'' and $\frac{1}{2}$ ''x9'' machine bolts placed 2'', 6'' and 1' 9'' from the front ends.
- On a centerline on the upper edge at the back end of stringers bore two $\frac{3}{8}$ '' holes 4 $\frac{1}{4}$ '' apart, 3'' from the end for the U bolts.
- Place the 4''x4''x12'' blocks between the stringers and rear axle and fasten stringers with U bolts.
- Bore a $\frac{3}{4}$ '' hole on a centerline at the front end of the stringers 3'' from the end.
- Block the stringers up under the front axle.
- Bore holes through stringers for end uprights with $\frac{1}{2}$ '' bit and fasten uprights in place.
- Fasten the end cross pieces in place, using two 16d nails in each upright.
- Cut the braces for front uprights triangular in shape and nail to the stringers so as to fit snugly against the front uprights. Use four 16d nails for each brace.
- Cut an opening in the upper edge of the front cross piece at the center for the rear end of the reach.
- Fasten the rear end of the reach to the front cross piece by bolting the $\frac{3}{8}$ ''x2''x16'' piece of iron to the top of the reach and back side of the cross piece. Use the $\frac{3}{8}$ ''x2 $\frac{1}{4}$ '' machine bolts.
- Bend the $\frac{3}{8}$ ''x2''x10'' iron for clevis as shown in the detail drawing. Place the link in position and fasten the clevis to the front end of the reach with the two $\frac{3}{8}$ ''x3'' machine bolts.
- Place the eye bolt through the stringers at front.
- Nail the floor to stringers and end uprights, using two 8d nails at each joint.
- Fasten the front end diagonal braces and the lower side cleats to the floor by using two 8d nails at each board.

ROUGHAGE FEED RACK FOR SWINE

Material Required.

Lumber—1 piece 2''x12''x12' 0'' any kind of lumber
 3 pieces 2''x4''x12' 0'' any kind of lumber
 1 piece 13/16''x10''x12' 0'' any kind of lumber
 9 pieces 13/16''x3''x12' 0'' any kind of lumber

Hardware—16 16d common nails
 44 10d common nails
 $\frac{3}{4}$ lb. 6d common nails

Stock Bill.

Pieces	Finished Dimensions	Use
2	2''x12''x3' 0''	Ends
2	2''x12''x2' 9''	Ends
4	2''x4''x4' 0''	End uprights
4	2''x4''x5' 4''	Horizontal frame
2	13/16''x10''x5' 8''	Trough
26	13/16''x3''x3' 1''	Side upright slats
2	13/16''x3''x24''	End slats
2	13/16''x3''x22 $\frac{1}{2}$ ''	End slats
2	13/16''x3''x21''	End slats
2	13/16''x3''x19 $\frac{1}{2}$ ''	End slats
2	13/16''x3''x18''	End slats

Directions.

1. Cut all pieces to finished dimensions.
2. Assemble the frame by fastening the horizontal 2''x4'' pieces in place. Drive two 16d common nails through the end uprights in each end of the horizontal pieces.
3. Bevel the end pieces to the dimensions shown in the drawing and fasten them to the uprights with 10d nails. The 2''x4'' pieces should be placed so that their outside edges will be 10'' apart at the bottom and 24'' apart at the top. The nails may be driven from the inside.
4. Lay out and cut the bevels at the ends of the end slats and fasten in place with two 6d common nails at each joint.
5. Fasten the side slats in place using two 6d common nails at each joint.
6. Place the two pieces for the trough so that the lower edge is 7'' and the upper edge 2'' from the end of the end piece and fasten with three 10d nails through the end plank into each end.

ROUGHAGE FEED RACK FOR CATTLE

Stock Bill.

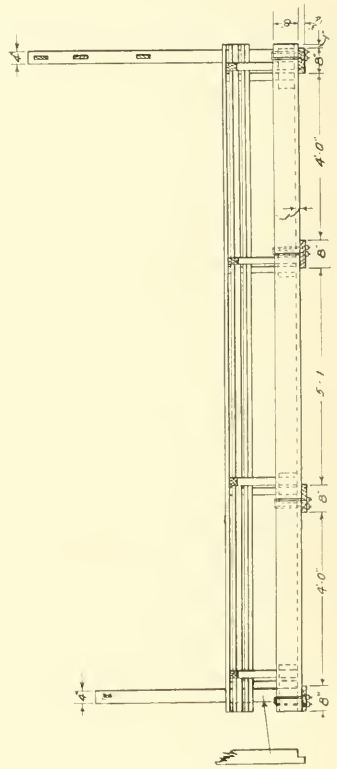
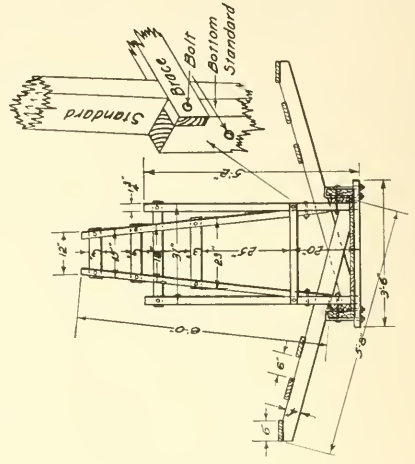
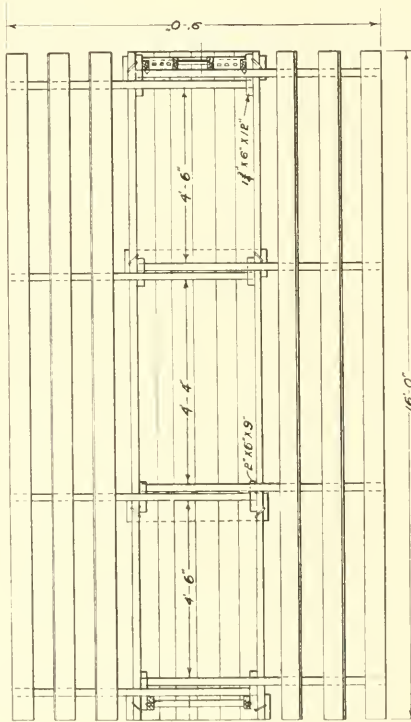
Pieces	Finished Dimensions	Use
4	6" D x 6' 0"	Corner posts
6	6" D x 19' 0"	Side beams
6	6" D x 6' 0"	End beams
2	4" D x 17"	Braces
28	2" D x 3' 4"	Partitions
4	1"x8"x9' 6"	Side boards
2	1"x8"x5' 0"	End boards
24	$\frac{3}{4}$ "x6" dowels	Mortise and tenon joints

Directions.

Rough poles are to be used in the construction of this rack and the diameter of the main pieces may be slightly over or below 6" and yet do just as well. A piece may naturally be tapering from 6" at the large end to $4\frac{1}{2}$ " or 5" at the small end and yet be just as good.

1. Cut all pieces to dimensions called for in stock bill.
2. Lay out and bore 2"x4" mortises in corner posts at places indicated in the drawing.
3. Cut a 2"x4" tenon at both ends of all beams.
4. Cut a 2"x4" tenon at both ends of the braces.
5. Bore 2" holes 2" deep and 18" apart in lower edge of top beams and upper edge of middle beams.
6. Assemble the rack in the following order: (a) partitions to beams; (b) braces between beams; (c) side beams to corner posts; (d) end beams to corner posts; (e) boards. The corner posts and beams should be snugly drawn together while the $\frac{3}{4}$ " hole is being bored for the dowel. The side boards may be nailed to the inside edge of the corner posts and braces. A piece of 2"x4" may be nailed to the corner posts between the middle and bottom stringer and the end boards nailed to it.

Hay Rack



HAY RACK

Material Required.

Lumber—2 pieces 2''x8''x16'⁷/₈ 0'' yellow pine
 2 pieces 2''x8''x14' 0'' yellow pine
 6 pieces 2''x4''x12' 0'' yellow pine
 1 piece 2''x4''x6' 0'' yellow pine
 1 piece 2''x6''x8' 0'' yellow pine
 12 pieces 1''x6''x16' 0'' yellow pine
 1 piece 1''x6''x3' 0'' yellow pine

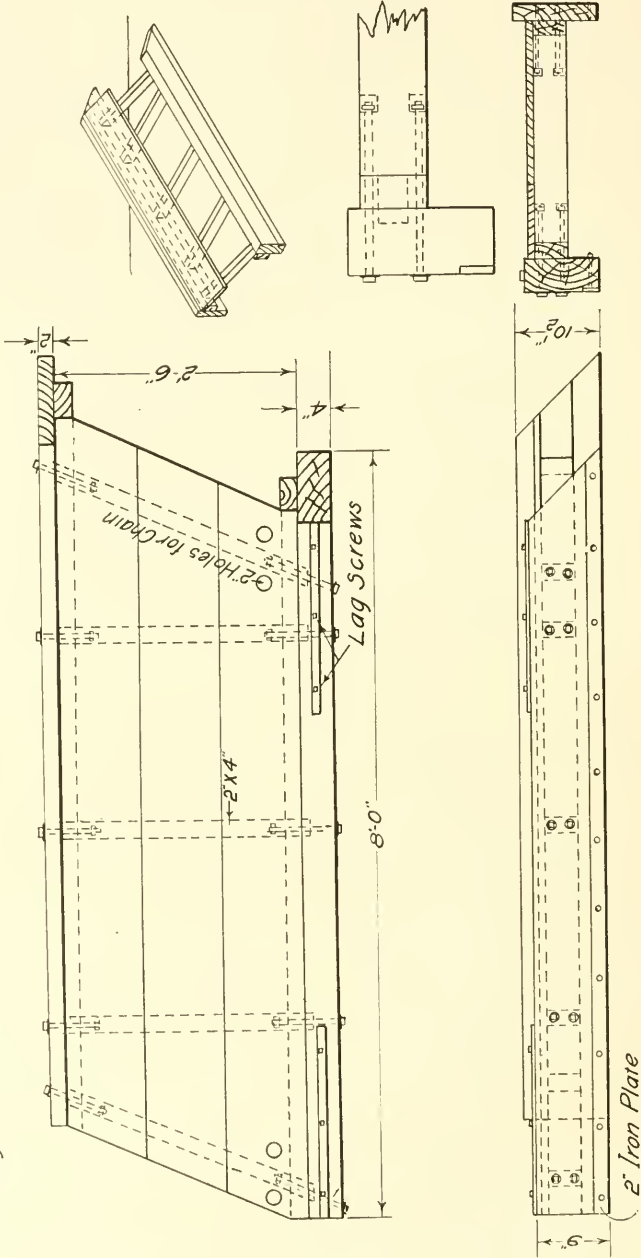
Hardware—8 10'' hay rack clamps

16 carriage bolts ³/₈''x5'' inside boards on arms
 8 carriage bolts ³/₈''x4¹/₂'' outside board on arms
 12 carriage bolts ³/₈''x4'' plates to stringers
 8 carriage bolts ¹/₄''x4'' front and rear standards
 2 carriage bolts ¹/₂''x3¹/₂'' front standard at bottom
 4 carriage bolts ¹/₂''x6'' standards at bottom
 2 carriage bolts ³/₈''x4'' cross brace front standard
 48 10d common nails for bottom

Stock Bill.

Pieces	Finished Dimensions	Use
2	1 ³ / ₄ ''x8''x16' 0''	Stringers
4	1 ³ / ₄ ''x8''x3' 6''	Cross rests
5	1''x6''x16' 0''	Floor
1	1''x4 ¹ / ₂ ''x16' 0''	Floor
4	1 ³ / ₄ ''x6''x12''	Plates
4	1 ³ / ₄ ''x6''x9''	Plates
8	1 ³ / ₄ ''x3 ³ / ₄ ''x5' 8''	Arms
6	⁷ / ₈ ''x6''x16' 0''	Top boards
2	1 ³ / ₄ ''x3 ³ / ₄ ''x5' 2''	Rear standard
2	1 ³ / ₄ ''x3 ³ / ₄ ''x20''	Bottom front standard
2	1 ³ / ₄ ''x3 ³ / ₄ ''x6' 0''	Front standard
1	⁷ / ₈ ''x3''x2' 7''	Brace at front standard
1	⁷ / ₈ ''x3''x23''	Brace at front standard
1	⁷ / ₈ ''x3''x18''	Brace at front standard
1	⁷ / ₈ ''x3''x15''	Brace at front standard
1	1 ³ / ₄ ''x3 ³ / ₄ ''x2' 8''	Brace rear standard

King Road Drag



KING ROAD DRAG

Material Required.

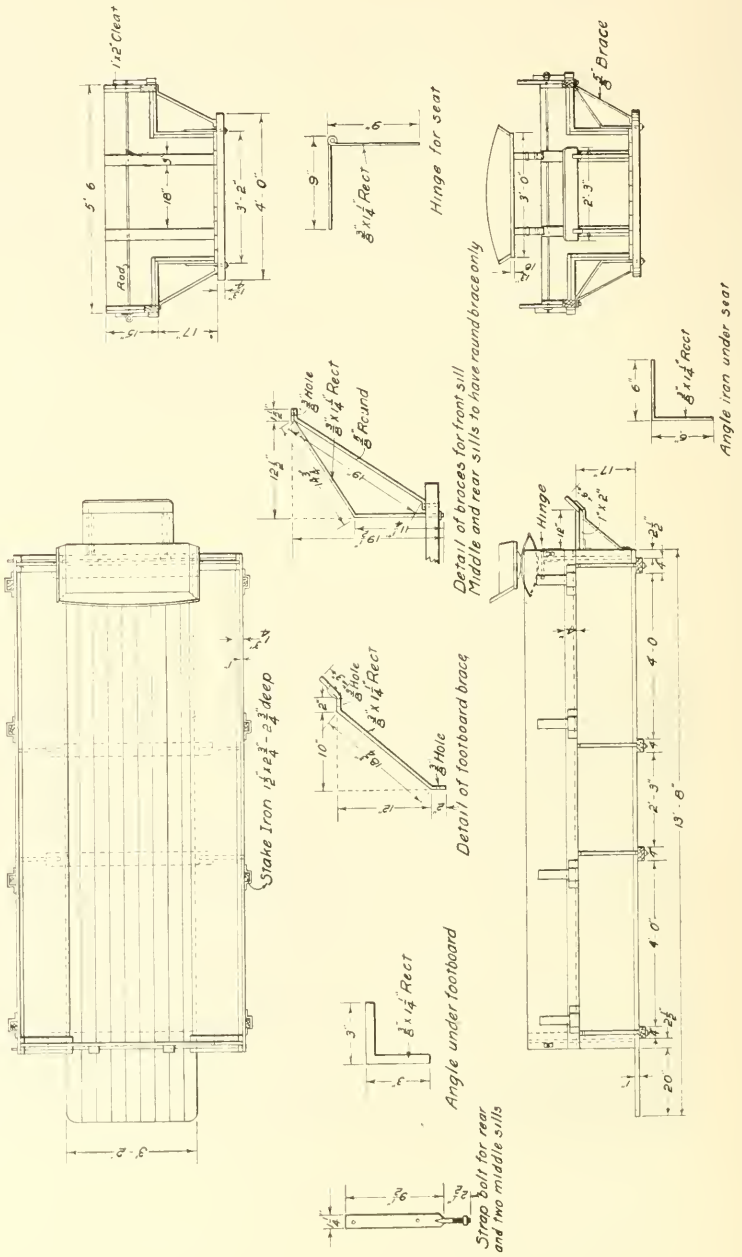
Lumber—1 piece white oak or ash 4''x9''x8' 0'' front
 1 piece white oak or ash 2''x10½''x8' 0'' back
 2 pieces white oak or ash 2''x4''x8' 0'' platform rests
 1 piece white oak or ash 2''x4''x12' 0'' for cross bars
 3 pieces pine 1''x10''x8' 0'' platform

Hardware—5 machine bolts $\frac{1}{2}$ ''x10'' for front
 5 machine bolts $\frac{1}{2}$ ''x8'' for rear
 11 carriage bolts $\frac{3}{8}$ ''x4½'' for iron plate
 6 lag screws $\frac{3}{8}$ ''x3'' for top iron straps
 30 flat head bright wood screws 2'' No. 12 for platform
 2 pieces iron $\frac{1}{4}$ ''x1½''x2' 0'' for rub irons
 1 piece iron $\frac{3}{8}$ ''x2''x8' 0''



Fig. 40. King Road Drag in Use.

Grain Bed



GRAIN BED

Material Required.

Lumber—(Poplar)

Pieces	Finished Dimensions	Use
4	$1\frac{3}{4}'' \times 4'' \times 4' 0''$	Cross sills
7	$1'' \times 4'' \times 13' 8''$	Floor
2	$1'' \times 5'' \times 13' 8''$	Floor
4	$1'' \times 8\frac{1}{2}'' \times 12' 0''$	Lower side boards
2	$1'' \times 13'' \times 12' 0''$	Upper floor
2	$1\frac{3}{4}'' \times 2'' \times 12' 0''$	Upper side pieces
2	$1'' \times 11'' \times 12' 0''$	Upper side boards
8	$1\frac{1}{2}'' \times 2\frac{3}{4}'' \times 12''$	Stakes
4	$1'' \times 8\frac{1}{2}'' \times 3' 0''$	End gates
2	$1'' \times 7\frac{1}{2}'' \times 5' 4''$	Rear end gate
1	$1'' \times 8'' \times 5' 4''$	Front end gate
1	$1'' \times 13'' \times 3' 0''$	Seat bottom
1	$1'' \times 7'' \times 3' 4''$	Seat back
2	$1'' \times 4'' \times 1' 5''$	Seat ends
4	$1\frac{3}{4}'' \times 2'' \times 8''$	Seat supports and spring rests
1	$1'' \times 12'' \times 2' 3''$	Foot platform
1	$1'' \times 6'' \times 2' 3''$	Foot board
2	$1\frac{3}{4}'' \times 3'' \times 2' 1''$	Cleats for front end gate
2	$1\frac{3}{4}'' \times 3'' \times 2' 7''$	Cleats for rear end gate
8	$1'' \times 2'' \times 1' 6''$	Side cleats for end gates
8	$1'' \times 2'' \times 13''$	Side cleats for end gates
4	$1'' \times 2'' \times 7''$	Side cleats for front end gate
4	$1'' \times 2'' \times 11''$	Side cleats for rear end gate
2	$1'' \times 2'' \times 13''$	Support for foot platform

Hardware—2 braces for front sill

6 braces for rear and middle sills

6 strap bolts for rear and middle sills

2 angle irons for footboard

2 angle irons for under seat

2 hinges for seat

2 braces for foot board

2 wagon box rods $\frac{3}{8}'' \times 5' 7''$

4 rectangular washers for wagon box rod

2 seat springs

8 stake irons $1\frac{1}{2}'' \times 2\frac{3}{4}'' \times 2\frac{3}{4}''$

1 lb. $2\frac{1}{4}''$ No. 9 barred car nails, for floor

1 gross flat head bright wood screws $1\frac{3}{4}''$ No. 8

16 round head blued screws $\frac{3}{4}''$ No. 7 for rod washers

2 carriage bolts $\frac{3}{8}'' \times 5''$ front brace at top

6 carriage bolts $\frac{3}{8}'' \times 4\frac{3}{4}''$ rear and middle braces at top

8 carriage bolts $\frac{3}{8}'' \times 3''$ all braces at bottom

2 carriage bolts $\frac{3}{8}'' \times 3\frac{1}{4}''$ footboard brace at bottom

2 carriage bolts $\frac{3}{8}'' \times 3''$ footboard brace at top

2 carriage bolts $\frac{3}{8}'' \times 2''$ footboard brace at top

2 carriage bolts $\frac{3}{8}'' \times 3''$ angle under footboard

2 carriage bolts $\frac{3}{8}'' \times 3\frac{1}{2}''$ angle under footboard

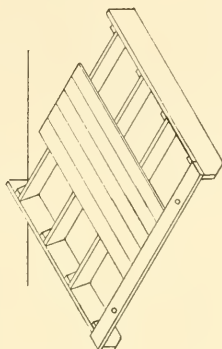
4 carriage bolts $\frac{3}{8}'' \times 4''$ hinge for seat

2 carriage bolts $\frac{3}{8}'' \times 3\frac{1}{2}''$ hinge for seat

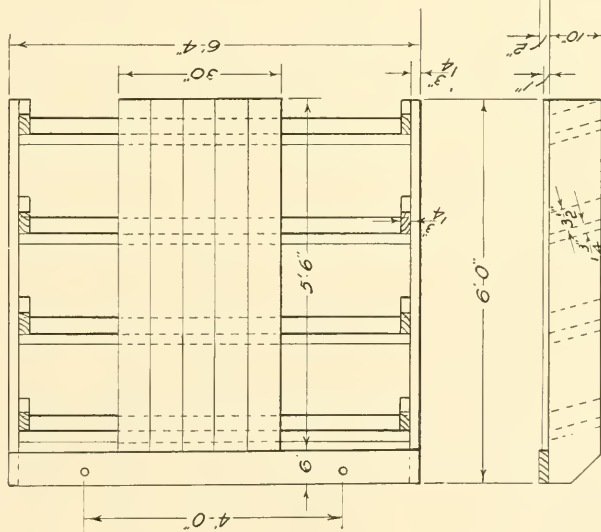
} As shown in detail drawings

Stock Bill

- 5 pieces 2"x10"x6'-0"
- 8 pieces 2"x4"x10"
- 1 piece 2"x6"x6'-4"
- 5 pieces 1"x6"x5'-6"
- 2 lbs 16d common nails
- ½ lb 8d common nails



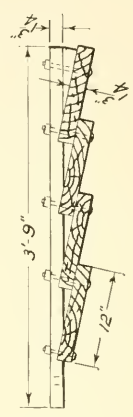
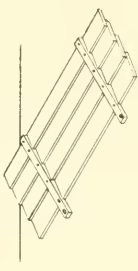
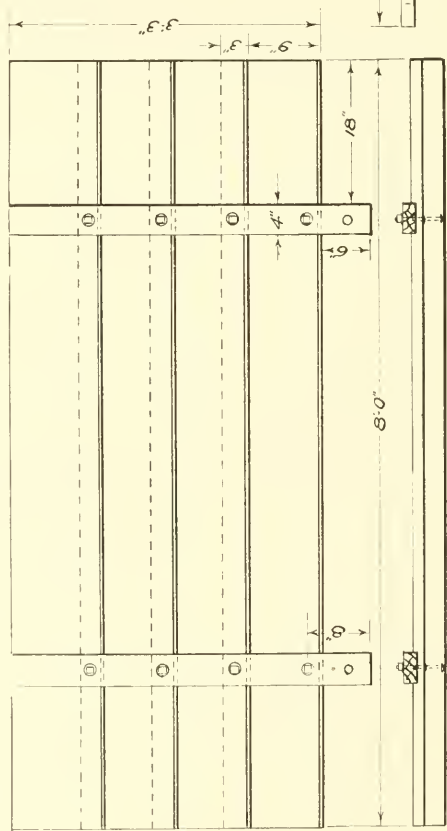
Land Leveler



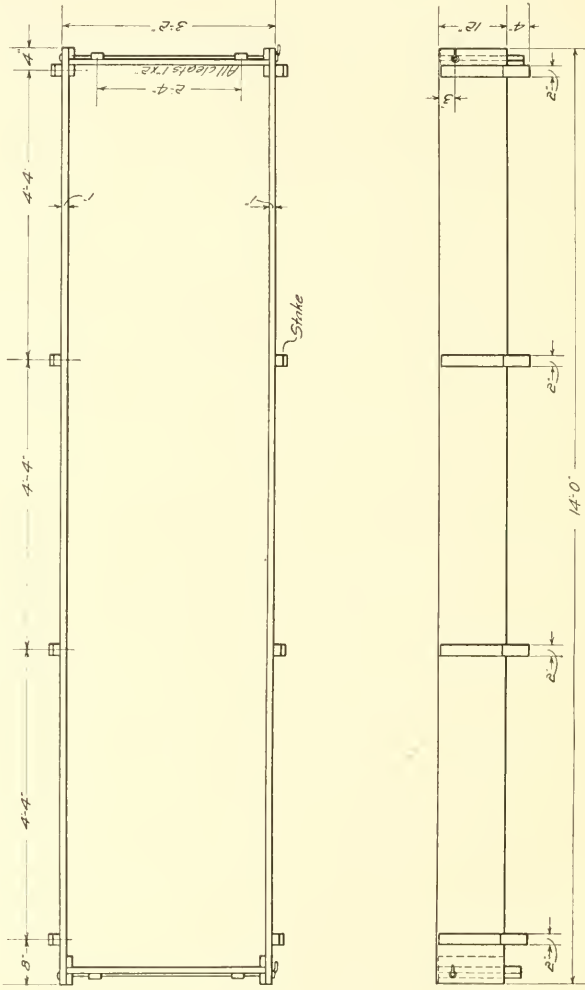
Planker

Stock Bill

- White or yellow pine
- 4 pieces 2"x4"x8'-0"
- 2 pieces 2"x4"x3'-9"
- 8 carriage bolts $\frac{1}{2}$ " x $5\frac{1}{2}$ "
- 2 carriage bolts $\frac{1}{2}$ " x $3\frac{3}{4}$ "
- 20 $\frac{1}{2}$ " washers



Wagon Box.



Material Required

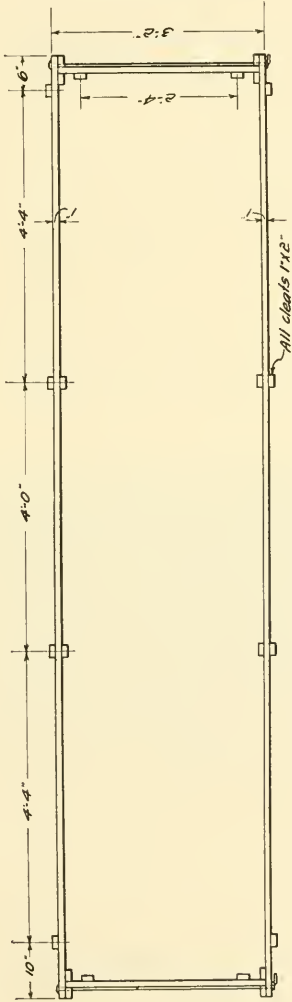
Lumber:

- 2 pieces poplar or basswood 1"x2"x14'-0"
- 1 piece " " " 1"x6"x12'-0"
- 1 " " " 1"x2"x13'-0"
- 1 " oak, maple or hardpine 2"x2"x11'-0"

Hardware:

- 2 wagon box rods $\frac{3}{8}$ "
- 28 carriage bolts $\frac{1}{4}$ " x $2\frac{1}{2}$ " for cleats
- 2 " " " $\frac{1}{4}$ " x $4\frac{1}{2}$ "
- 2 " " " $\frac{1}{4}$ " x 4"
- 8 " " " $\frac{1}{4}$ " x $3\frac{1}{2}$ " for stakes
- 6 " " " $\frac{1}{4}$ " x 3"
- 6 " " " $\frac{1}{4}$ " x $2\frac{1}{2}$ "

Top Wagon Box.



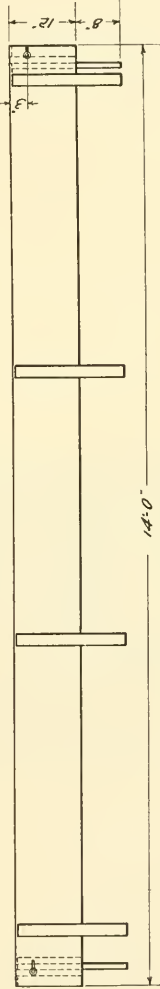
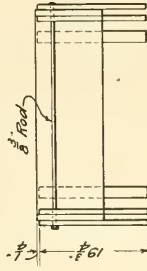
Material Required

Lumber:

- 2 pieces poplar or basswood 1x12"x14'-0"
- 1 piece " " " 1x12"x6'-0"
- 4 pieces " " " 1x2"x10'-0"

Hardware:

- 2 wagon box rods, $\frac{3}{8}$ "
- 8 carriage bolts $\frac{1}{2}$ " x $\frac{3}{4}$ " for side cleats
- 32 " " $\frac{1}{4}$ " x $\frac{1}{4}$ " for cleats at ends



SILO FORM

Material Required for a 12-ft. Form.

- Lumber—8 pieces soft wood 2''x10''x10' 0'' for ribs
 1 piece soft wood 2''x10''x8' 0'' for splices at joints
 3 pieces soft wood 2''x6''x10' 0'' for splices at joints and uprights for door
 3 pieces soft wood 2''x4''x14' 0'' for studs
 1 piece soft wood 2''x2''x10' 0'' for door
 1 piece soft wood 3''x4''x7' 0'' for wedges
 8 pieces soft wood 2''x4''x18' 0'' for posts for elevating the form
 150 ft. 4''x12' 0'' soft pine matched and dressed flooring for outside of inside form, and spacing blocks
- Hardware—2 sheets No. 20 galvanized iron 36''x21' 5'' for outside form
 12 pieces soft steel $\frac{1}{4}$ ''x1 $\frac{1}{4}$ ''x6'' for lugs
 24 iron rivets $\frac{1}{4}$ ''x $\frac{1}{2}$ '' for fastening lugs
 6 machine bolts $\frac{1}{2}$ ''x10'' threaded to the head for drawing outside form together
 64 machine bolts $\frac{1}{2}$ ''x4 $\frac{1}{2}$ '' with two washers each for splices at joints
 64 20d spikes for fastening studs to ribs.
 2 heavy T hinges for door
 5 lbs. 8d common nails for nailing flooring to ribs



Fig. 41. Silo Form Completed.

FARM BUILDINGS

The drawings of farm buildings on the following pages are only suggestive and it is expected that local conditions such as size of farm, type of farming and topography of the land at the farmstead will warrant changes. If however, any one who is building, will glean a suggestion from them on how to make the buildings handy and as a result the farming easier, it is thought that the plans will have served a useful purpose.

It may be stated that the plans in their arrangement and type of construction are such as are advocated by the better agriculturists.

The open front poultry house appears to be gaining in favor as it conserves the vitality of the fowl and consequently produces more vigorous chicks the following spring.

The hog house has these particularly commendable features: it is handy in arrangement; it has a ventilating system and admits sunlight in each individual pen.

Brood sows do so much better in rearing a litter of pigs in a portable house than in a big house where there are other hogs, even though they are in a pen by themselves, that the portable house is being used extensively. The A type of house is most generally used because of its simplicity and ease of construction.

The corn crib built as called for in the drawing serves a double purpose: a storage place for corn and a place between the two cribs for storing wagons, buggies or implements.

The implement shed should have a floor. The type of shed shown appears to be the most satisfactory. The entire front is a set of doors which roll by one another as shown in the detail drawing, making it handy to get machines in and out of any part of the shed. It has the advantage over the open front shed in that it keeps the fowl out and prevents the rain and snow from blowing in.

The floor plan of the small combination horse and dairy barn is only suggestive of an arrangement of the floor of a barn for a small dairy farm.

The average farmer wishes his horses and cows in the same building so as to save time and steps in doing the chores. With the horse and cow barn separated by a partition and the milk house outside of the barn there is little danger of the milk becoming contaminated. Modern barn construction calls for plenty of light. Thirty-two windows 2' 6"x3' 6", outside dimensions, furnishes approximately one square foot of window to twelve square feet of floor space. The Kind system of ventilation is advocated. Twelve fresh air inlets and four foul air flues are provided which should keep the air in the barn dry and pure. The engine room is separated from the milk house by a wall which keeps the oily odor of the engine from the milk. The alley between the barn and milk house is housed in so that one need not go outside in going from the barn to the milk house. On the second floor two driveways are provided which makes it easier for unloading hay and grain and provides a place for two loads in case of rain or at the end of a day. The granary should be housed in with a ceiling not less than nine feet high. Windows should be provided in the side and end of the barn for lighting the granary and alley. Double-hinged swinging doors are placed at each driveway. If sixteen instead of twelve foot posts are used, the roof will be high enough to permit the use of rolling doors which are usually preferred. Rolling doors may be used on the barn built to the dimensions called for in the drawing if they are hung so as to roll past each other. In this arrangement only one driveway can be open at a time. A retaining wall should be built not less than twelve feet from the barn and the span from the wall to the driveway bridged. By use of the bridge the light is not shut off from the stable as it would be if the approach were filled in against the barn.

Portable Hog House

Material Required

Lumber: white or Oregon pine or cypress

2 pieces 2"x8"x10'-0" - headers

3 " 2"x6"x8'-6" - runners

7 " 2"x4"x16'-0" - joists and frame

1 " 2"x4"x10'-0" - ridge

11 " 1"x10"x10'-0" - floor and saddle board

6 " 1"x10"x14'-0" - ends and door

22 " 1"x10"x9'-0" - roof

10 battens 16' long

Hardware:

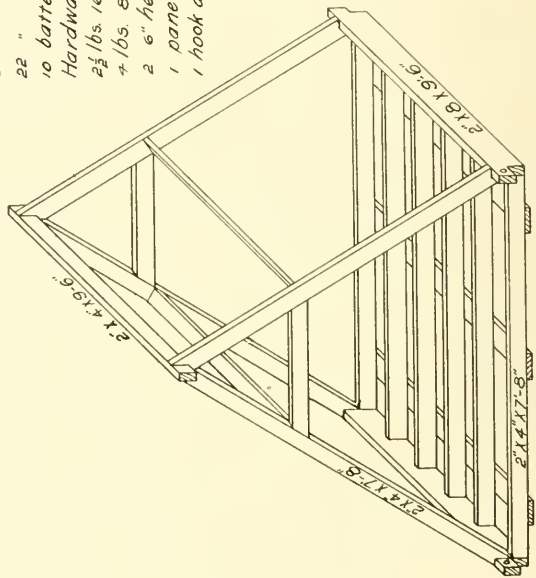
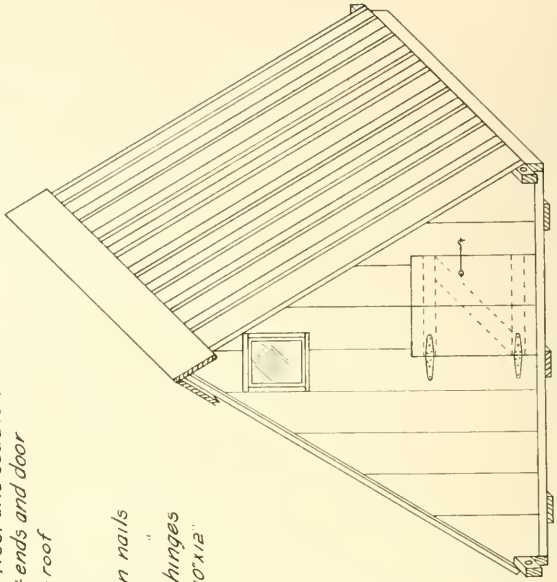
2 $\frac{3}{4}$ lbs. 16d common nails

4 lbs. 8d " "

2 6" heavy strap hinges

1 pane of glass 10"x12"

1 hook and staple



Colony Poultry House

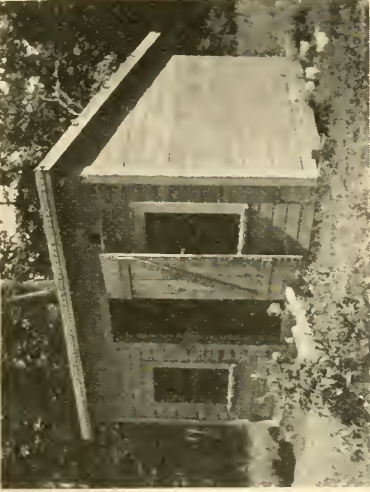
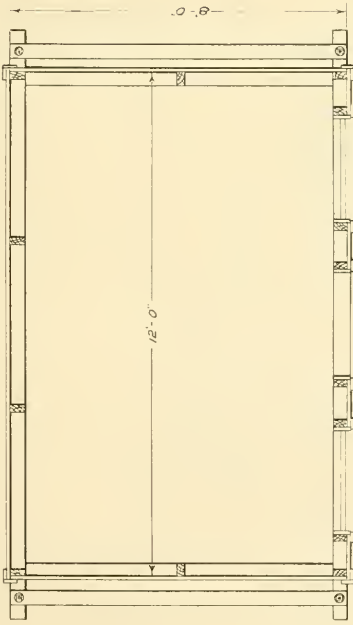
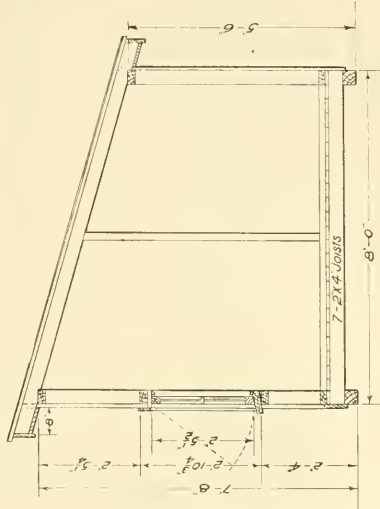
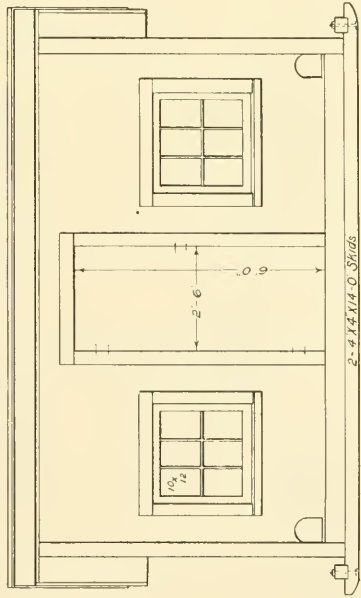


Fig. 42. Colony Poultry House.

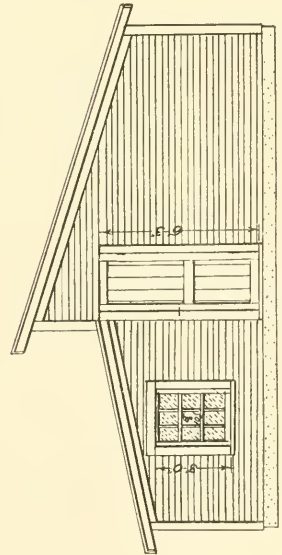
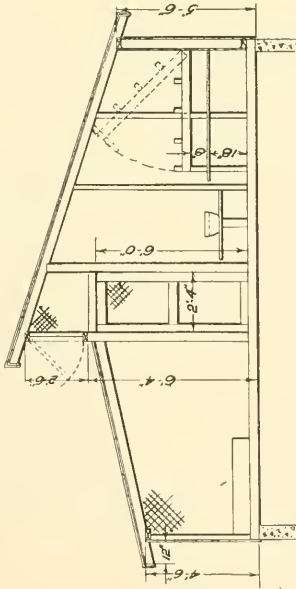
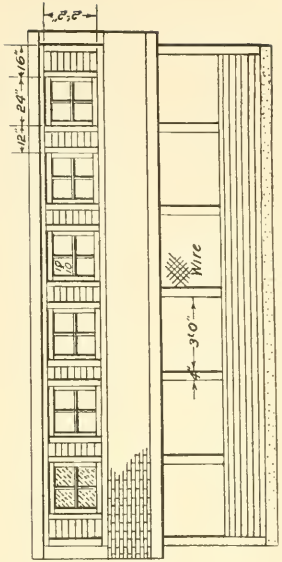
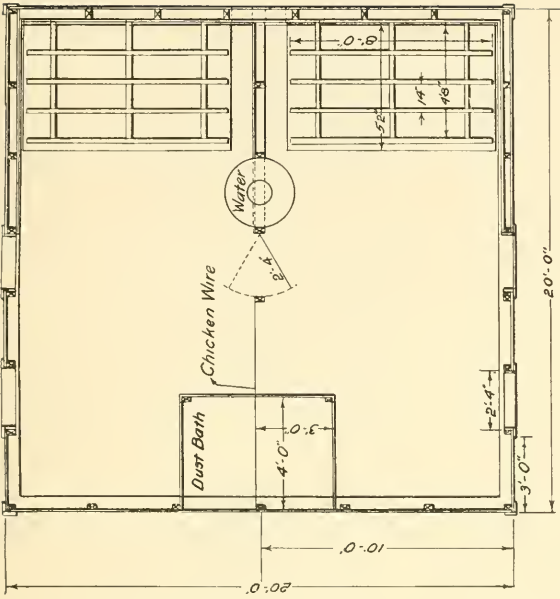


COLONY POULTRY HOUSE

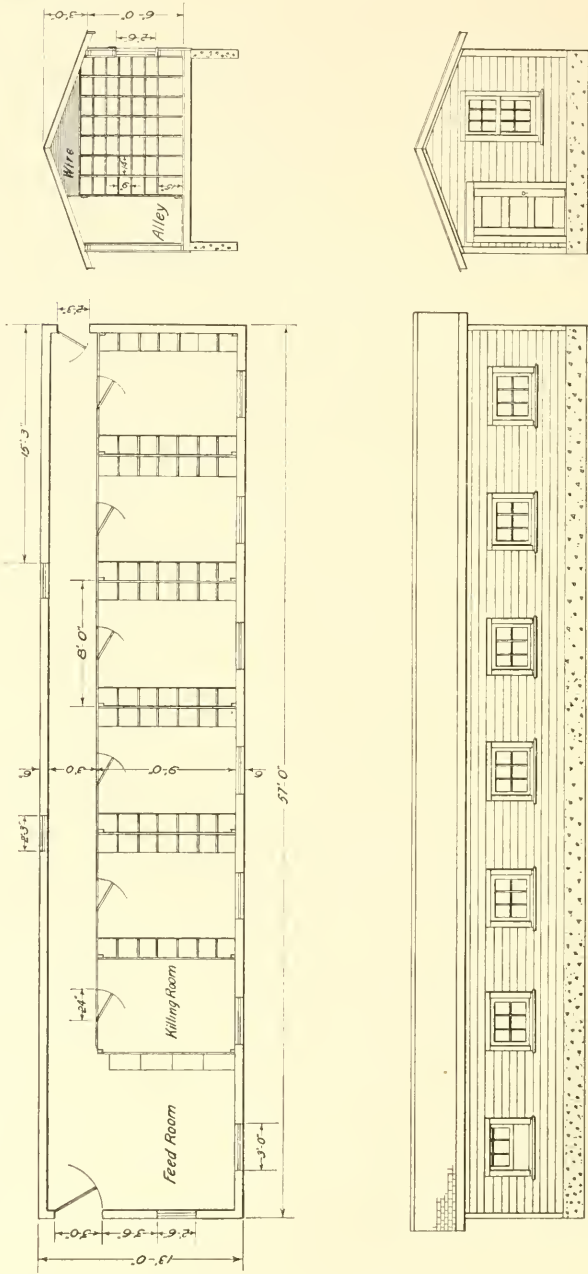
Material Required.

Lumber—2 pieces 4''x4''x14' 0'' Skids
 2 pieces 4''x4''x8' 0'' Cross ties
 7 pieces 2''x4''x8' 0'' Joists
 1 piece 2''x4''x12' 0'' Studding
 4 pieces 2''x4''x14' 0'' Studding
 2 pieces 2''x4''x10' 0'' Studding
 1 piece 2''x4''x12' 0'' Girts
 7 pieces 2''x4''x10' 0'' Rafters
 4 pieces 2''x4''x12' 0'' Plates and sole pieces
 2 pieces 2''x4''x8' 0'' Sole pieces
 27 pieces 1''x3 $\frac{1}{4}$ ''x12' 0'' Floor
 25 pieces 6''x12' 0'' Drop siding front and back
 32 pieces 6''x8' 0'' Drop siding ends and back
 13 pieces 1''x8''x14' 0'' Roof boards
 2 pieces 1''x6''x14' 0'' Fascia
 2 pieces 1''x6''x10' 0'' Fascia
 2 pieces 1''x10''x14' 0'' Plancher
 2 pieces 1''x10''x10' 0'' Plancher
 1 piece 2''x6''x8' 0'' Window sills
 2 pieces 1''x4''x10' 0'' Window frames
 2 pieces 1''x4''x10' 0'' Window easing
 2 pieces 1''x4''x10' 0'' Door casing
 4 pieces 1''x4''x8' 0'' Corner boards
 2 pieces 1''x4''x12' 0'' Corner boards
 1 piece 1''x4''x10' 0'' Door
 5 pieces 3 $\frac{1}{4}$ ''x14' 0'' flooring—Door
 2 windows 10''x12''—6 light
 1 $\frac{1}{4}$ rolls of prepared roofing or 6 bundles shingles.

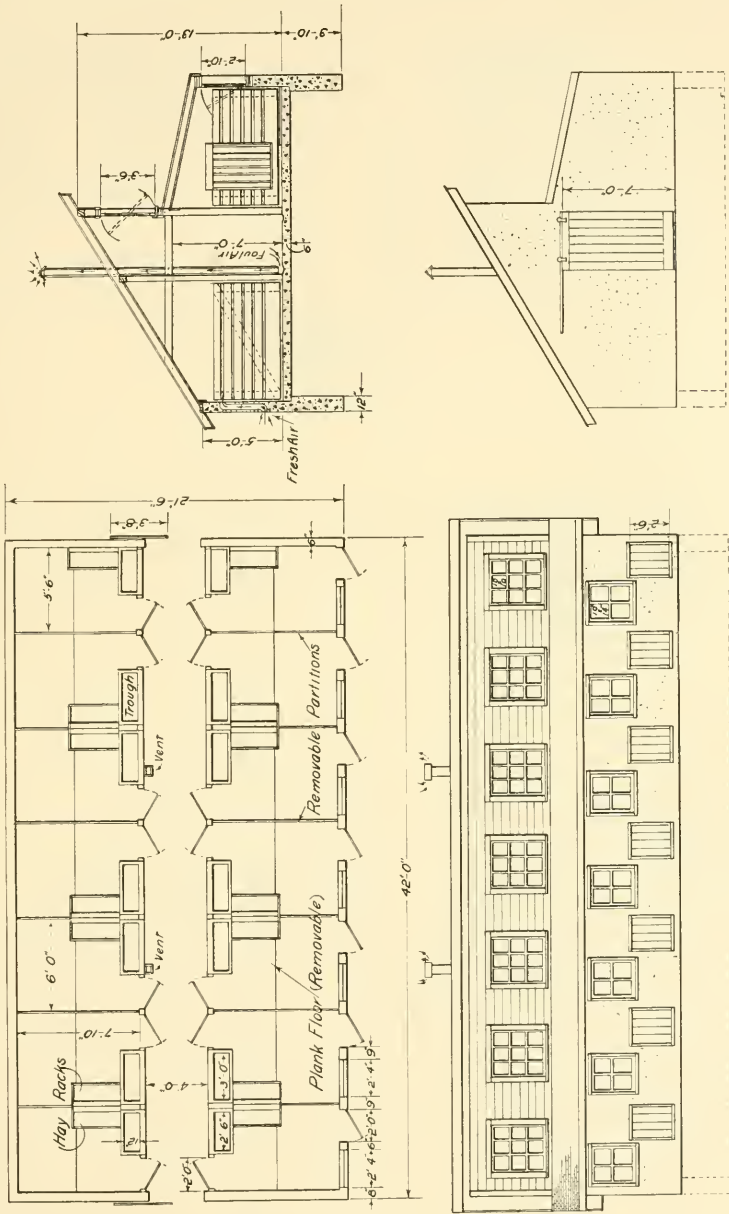
Hardware—1 quart priming paint
 1 quart finishing paint
 4 carriage bolts $\frac{1}{2}$ ''x6 $\frac{1}{2}$ '' with washers
 2—6'' heavy strap hinges
 4 butt hinges 2 $\frac{1}{2}$ ''x2 $\frac{1}{2}$ '' for windows at top
 3 screen door hooks with screw eyes
 1—6'' hasp and staple
 1 padlock
 10 lbs. 8d common nails
 2 lbs. 20d common nails



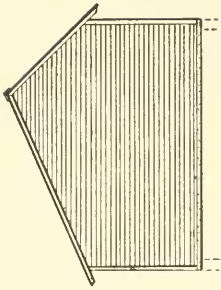
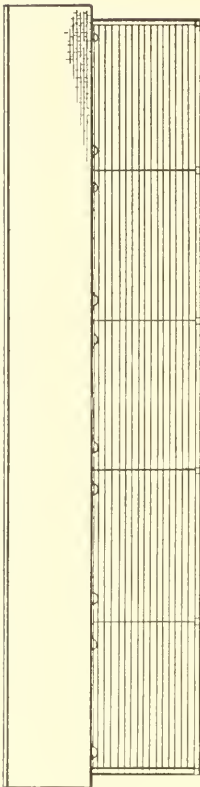
Pigeon House



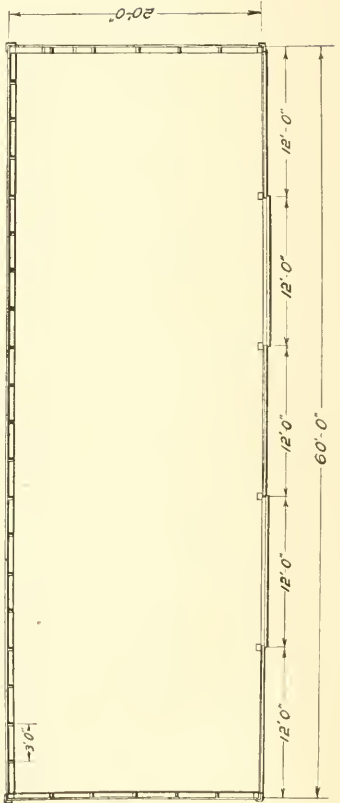
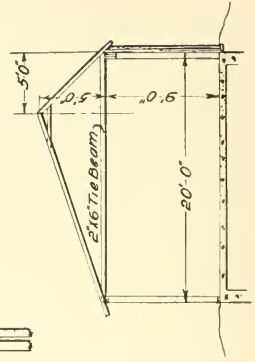
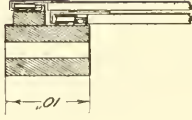
Hog House



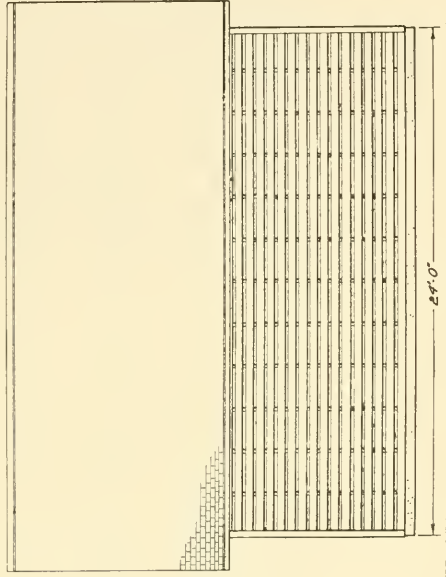
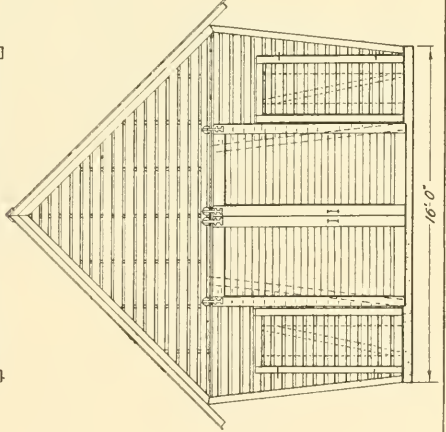
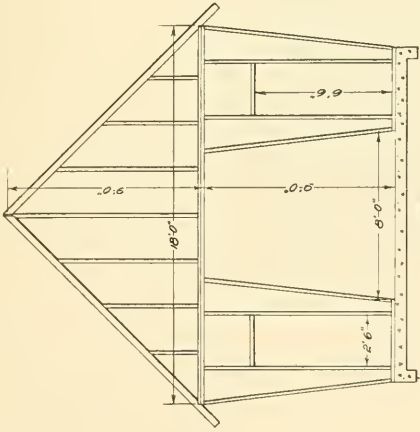
Implement Shed



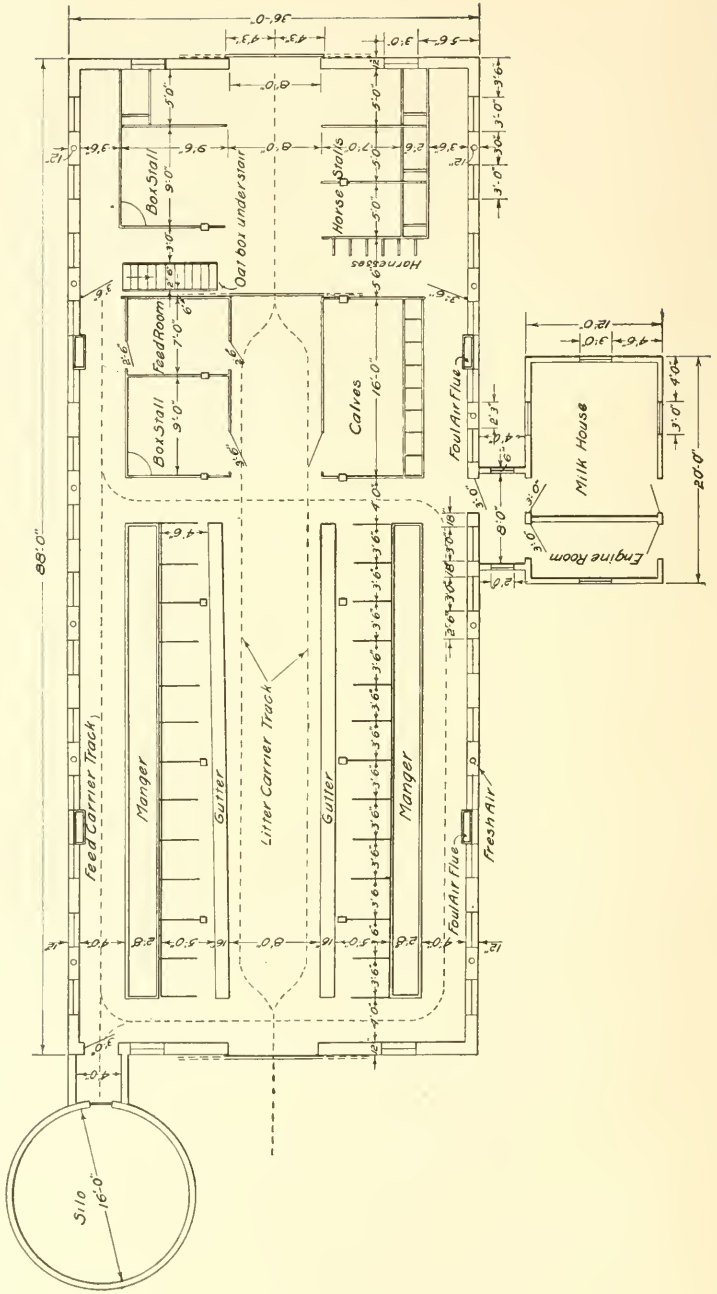
Detail of Doors and Hangers.



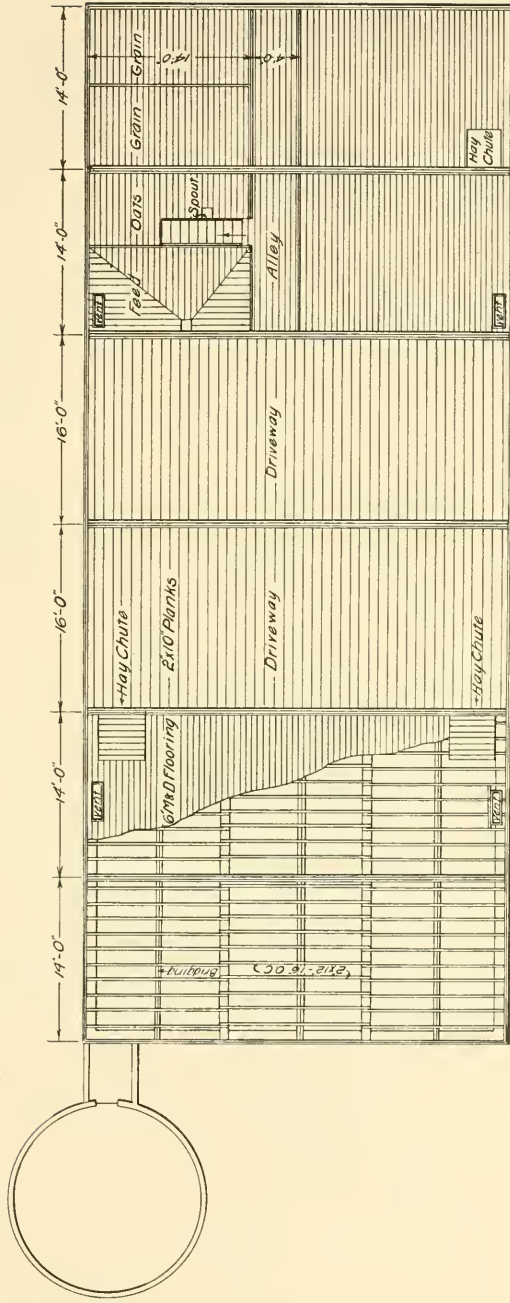
Corn Crib



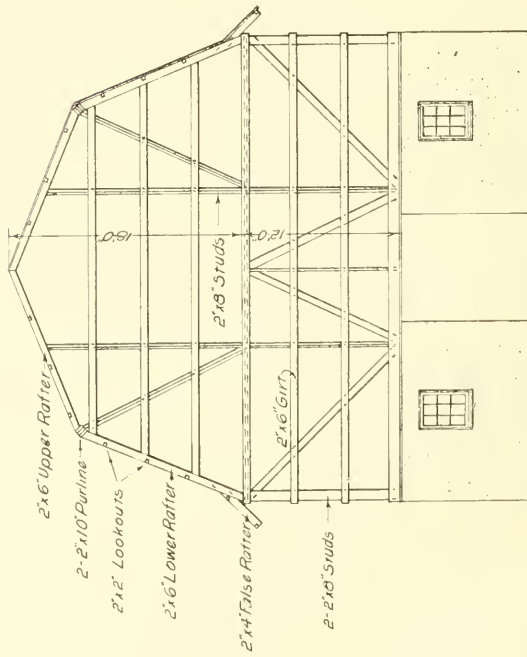
Combination Dairy and Horse Barn



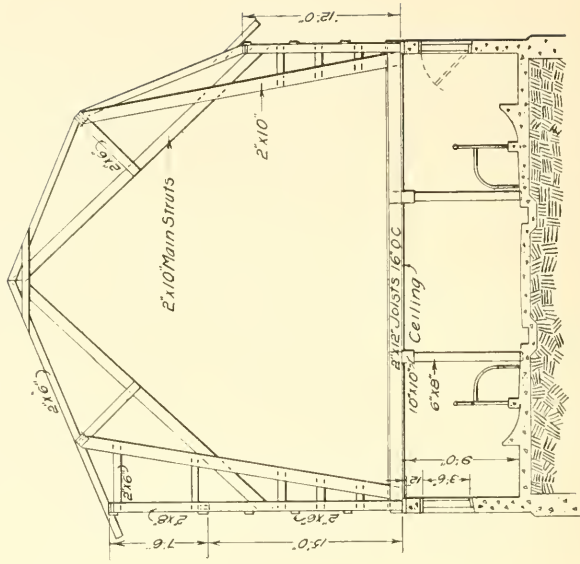
Combination Dairy and Horse Barn
Second Floor



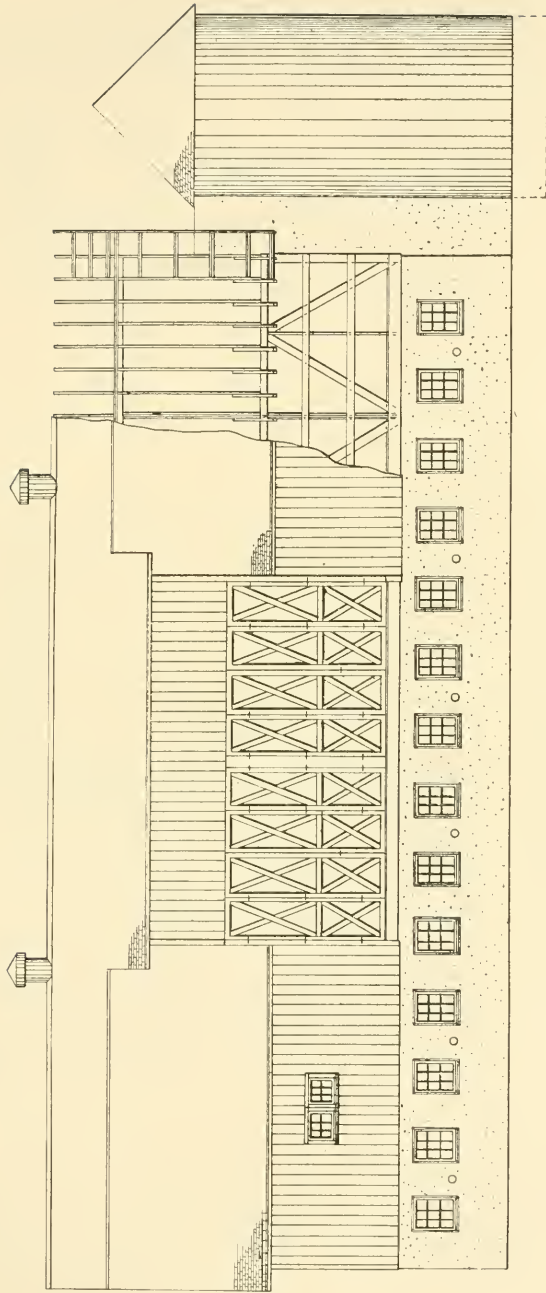
End Elevation of Dairy Barn



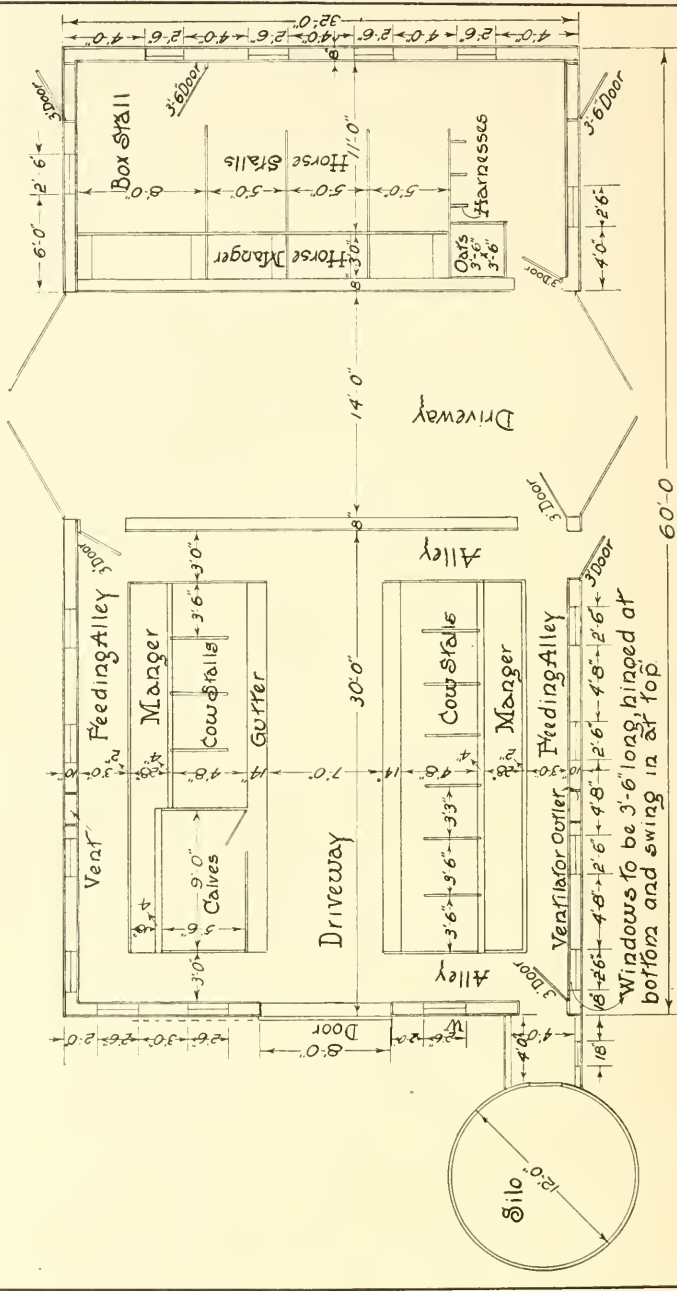
Cross Section of Dairy Barn



Side Elevation of Dairy Barn



Combination Horse & Cow Barn



BELT LACING, KNOTS, HITCHES AND SPLICES

Of the many good ways of lacing a belt, only two standard methods are here illustrated. It is believed that if one can lace a belt well, using either of these methods he will be able to do such lacing as is usually necessary for transmitting power in farm machinery.

Scarcely a day passes on the farm that there is not a call for a knowledge of the more common knots, hitches and splices. The life and use of a rope is greatly enhanced by a knowledge of how to use, care for and repair it. Frequently a hay rope breaks and if the farmer knows how to make the long splice, it may save a trip to town, considerable time and perhaps a few loads of hay.

Only the more useful knots, hitches and splices are shown. It is believed that if a country boy can make the long and short splice, properly crown the end of a rope and make the knots and hitches illustrated, he will be equipped for manipulating rope for all practical farm purposes.

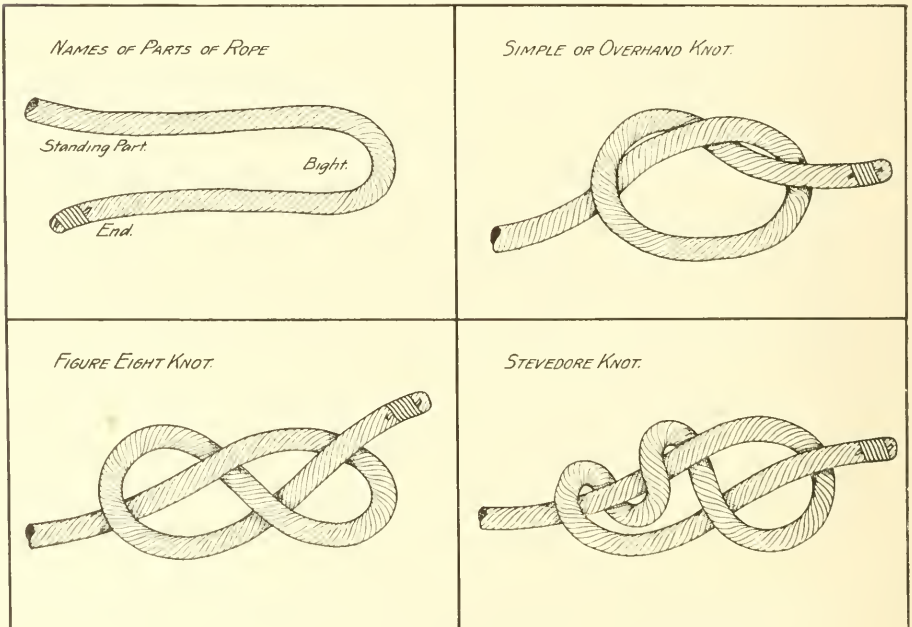
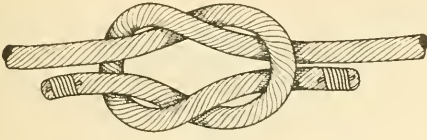
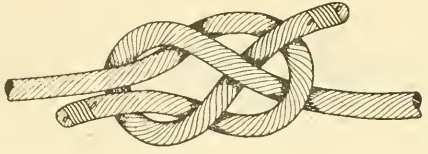


Plate 1.

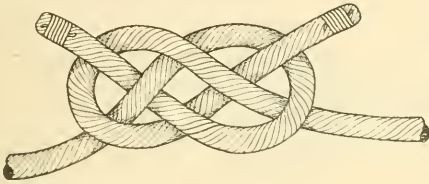
SQUARE KNOT.



SHEET BEND.



CARRICK BEND.



GRANNY KNOT.

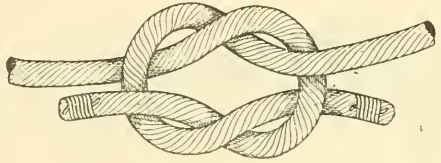
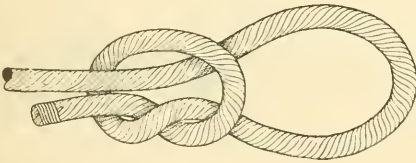
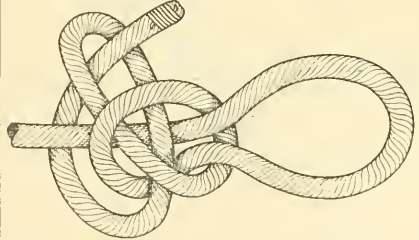


Plate 2

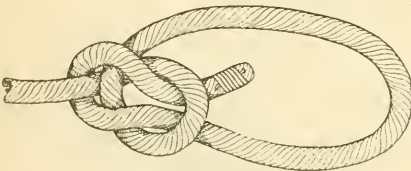
SLIP KNOT.



MANSER KNOT.



BOWLINE KNOT.



TEAMSTERS KNOT.

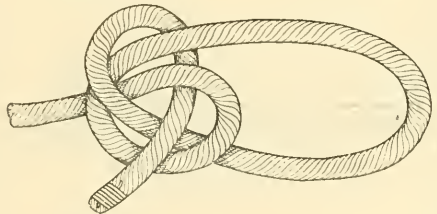
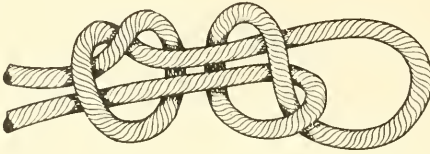
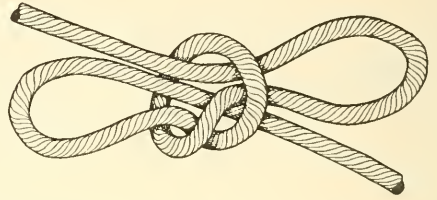


Plate 3

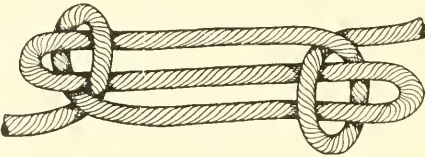
DOUBLE FLEMISH LOOP.



DOUBLE BOW KNOT.



SHEEP SHANK.



CAT'S PAW.

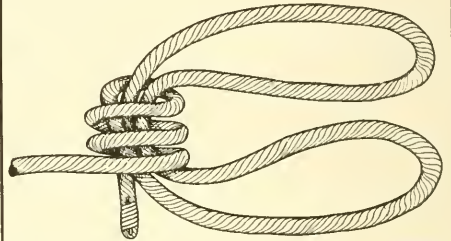
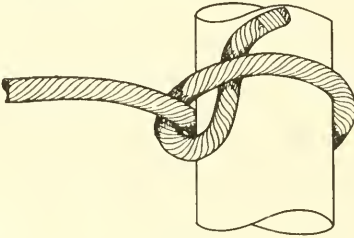
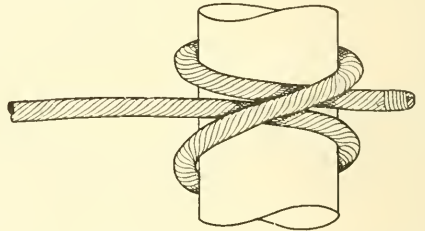


Plate 4

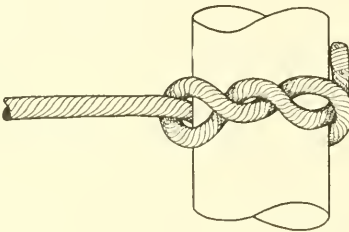
HALF HITCH.



CLOVE HITCH.



TIMBER HITCH.



COMBINED TIMBER AND HALF HITCH.

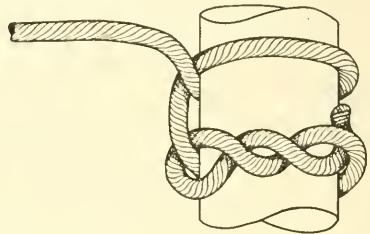


Plate 5

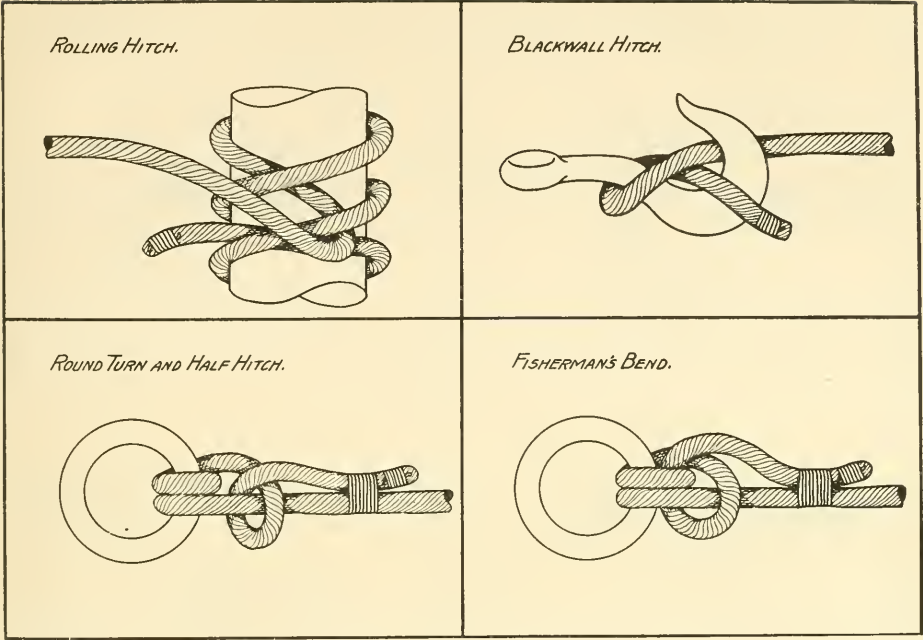


Plate 6

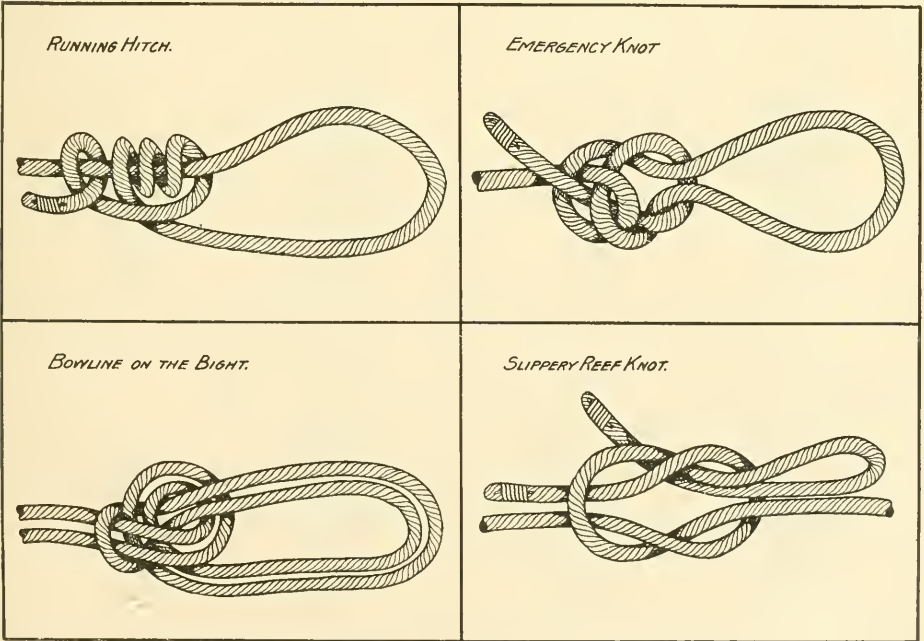


Plate 7

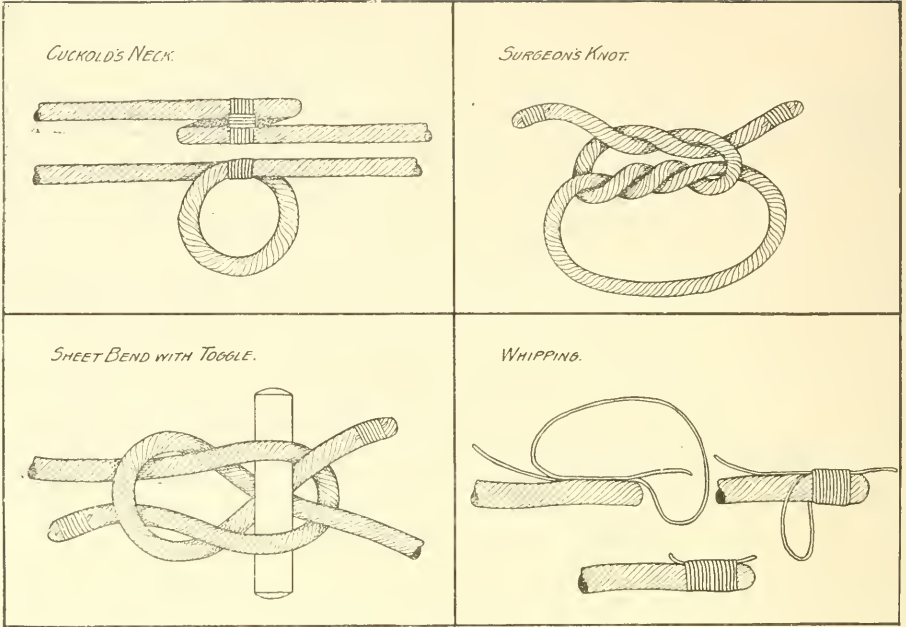


Plate 8

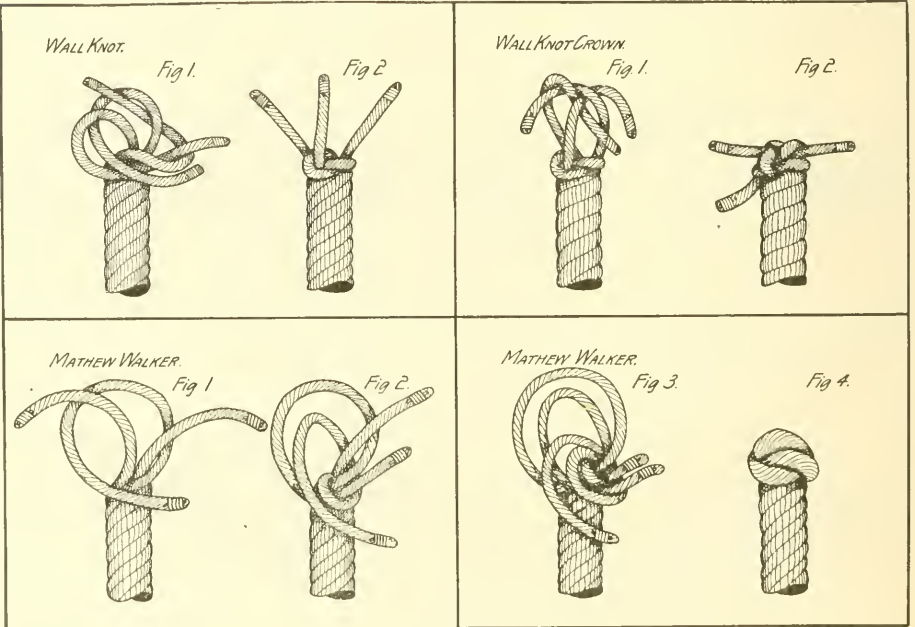


Plate 9

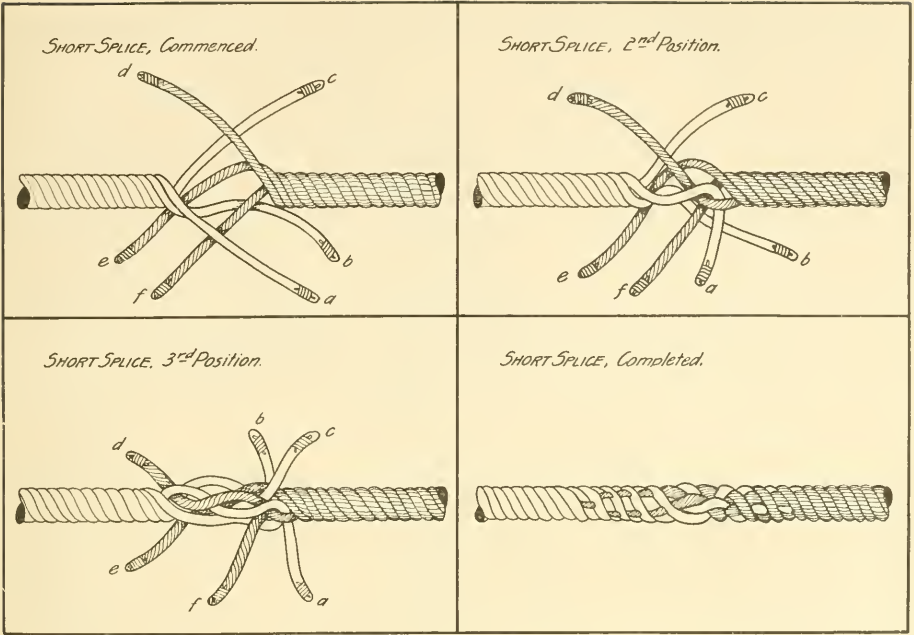


Plate 10

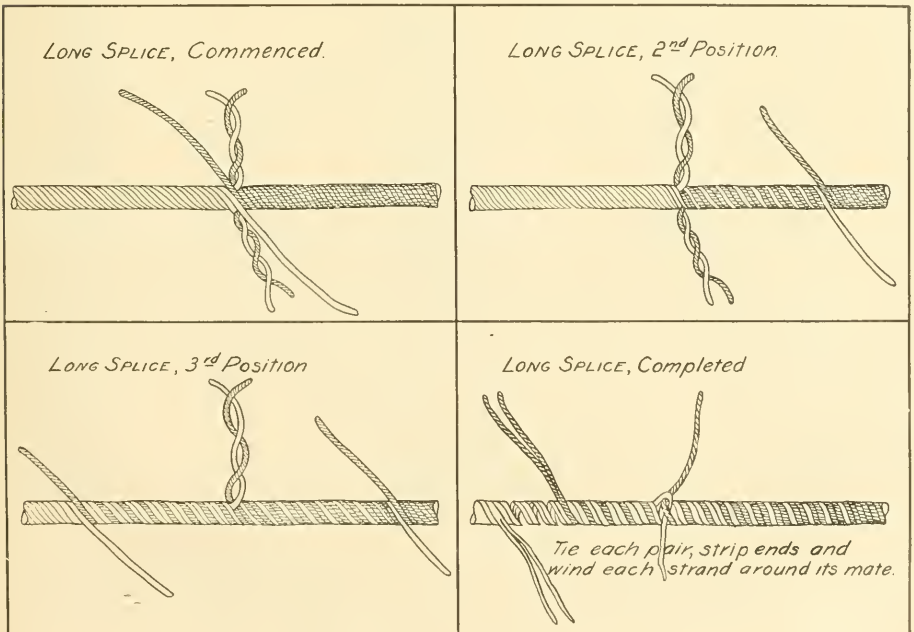
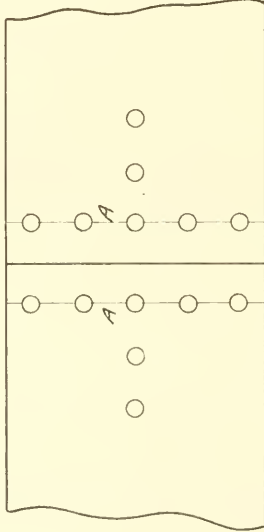
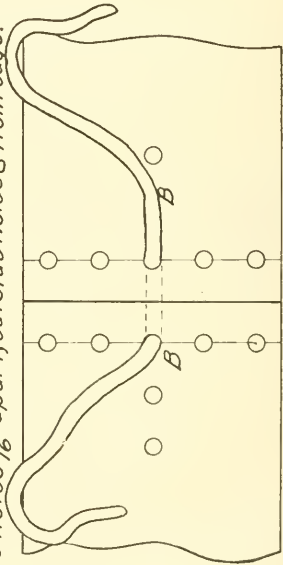


Plate 11

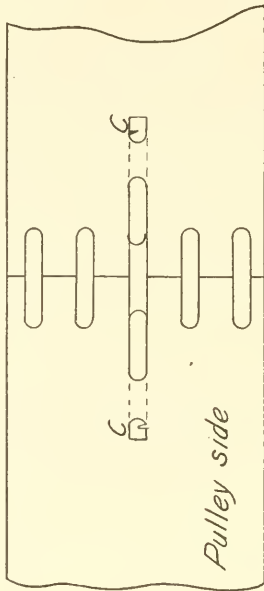
Lacing a Belt with a Rawhide Thong



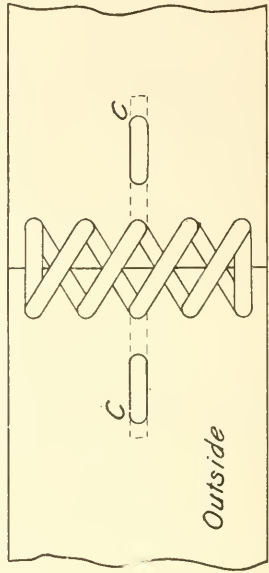
*Cut ends to be laced perfectly square
Draw lines, AA, $\frac{5}{8}$ " from ends and punch
5 holes $\frac{13}{16}$ " apart, outside holes $\frac{3}{8}$ " from edge.*



*Draw thong through center holes and
bring ends up tight*



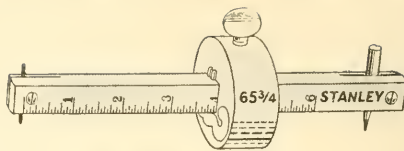
*Commence as at B and lace each way
keeping lace from twisting; lace to be
double on pulley side and end at C, C.*



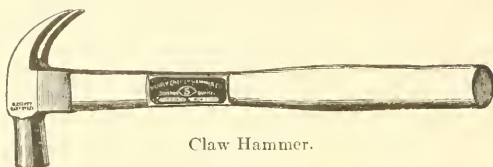
*Cut lace after passing through holes,
C, C, and nick with knife so it wont slip out.*



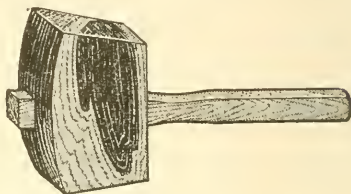
Hand Rip Saw.



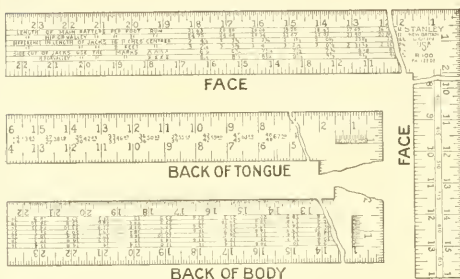
Marking Gauge.



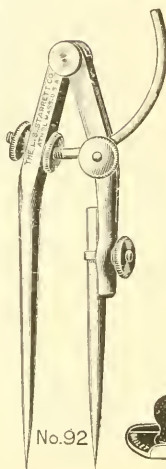
Claw Hammer.



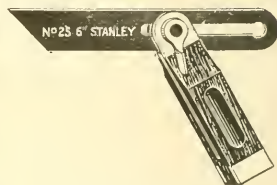
Carpenter's Mallet.



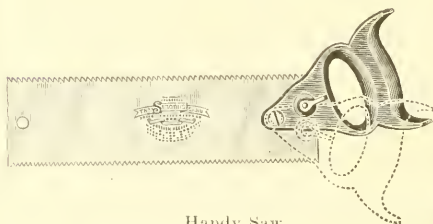
Stanley Steel Square.



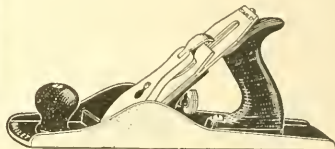
Dividers.



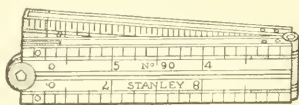
Eight-Inch T Bevel.



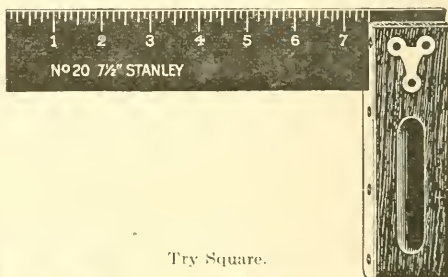
Handy Saw.



Jack Plane.



Two-Foot, Four Foot Rule.



Try Square.



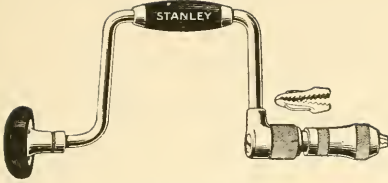
Socket Firmer Chisel.



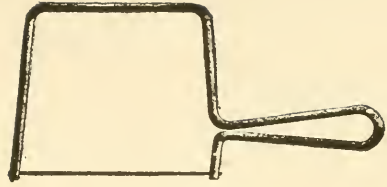
Screw Driver.



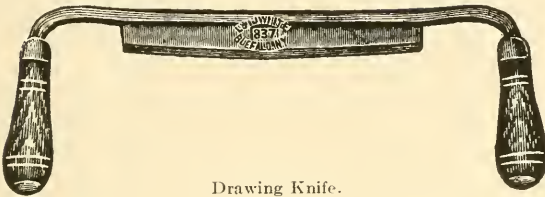
Combination Plier.



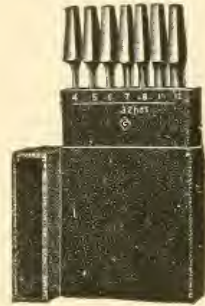
Ratchet Brace.



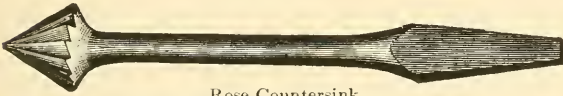
Coping Saw.



Drawing Knife.



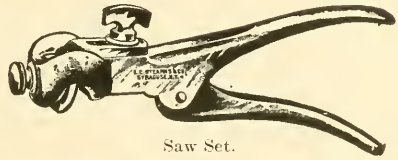
Set Twist Drill Bits.



Rose Countersink.



Combination Carborundum Stone.



Saw Set.



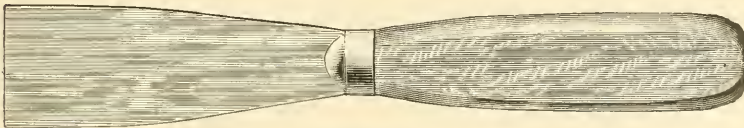
Flat Bastard Mill File.



Slim Taper Triangular File.



Auger Bit.



Putty Knife.

LIBRARY OF CONGRESS



0 013 974 059 2

